

EN	Gynecology
DE	Gynäkologie
ES	Ginecología
FR	Gynécologie
IT	Ginecologia

Page 682 to 722





**CUSCO**

- 29-8001-01 75 x 17mm
- 29-8001-02 75 x 32mm
- 29-8001-03 85 x 35mm
- 29-8001-04 100 x 37mm

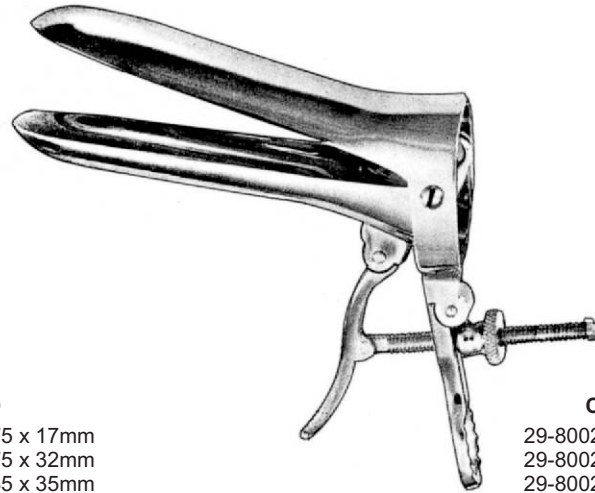

**CUSCO**

- 29-8002-01 75 x 17mm
- 29-8002-02 75 x 32mm
- 29-8002-03 80 x 32mm
- 29-8002-04 85 x 35mm
- 29-8002-05 110 x 35mm
- 29-8002-06 115 x 37mm



**CUSCO**

- 29-8003-01 75 x 32mm
- 29-8003-02 85 x 35mm
- 29-8003-03 100 x 35mm
- 29-8003-04 85 x 35mm ( with cold light carrier)
- 29-8003-05 (cold light carrier only)



**CUSCO**

- 29-8004-01 75 x 17mm
- 29-8004-02 85 x 17mm
- 29-8004-03 100 x 17mm



**CUSCO (Swiss pattern)**

- 29-8005-01 80 x 22mm
- 29-8005-02 100 x 25mm
- 29-8005-03 105 x 27mm
- 29-8005-04 115 x 27mm



**CUSCO'S**

- 29-8006-01 (LL)
- 29-8006-02 (L)
- 29-8006-03 (M)
- 29-8006-04 (S)
- 29-8006-05 (SS)
- 29-8006-06 (SSS)

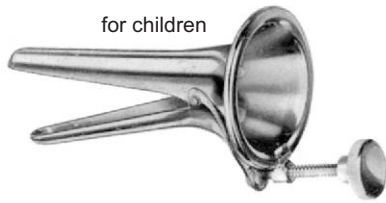

for children  
**COLLIN**  
 29-8007-01 55 x 10mm



**COLLIN**  
 29-8007-02 65 x 20mm

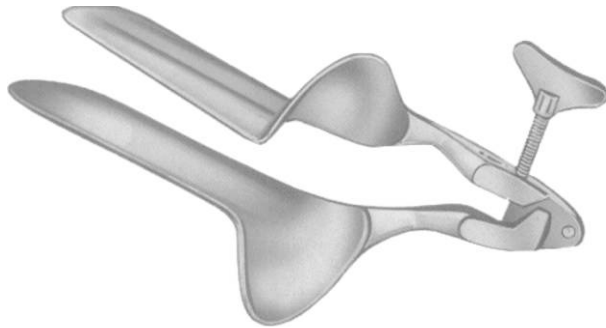

**Collin-Landau**  
 Medium 29-8007-03 35 x 100 mm



**Collin**  
 all 29-8007-12 30 x 85 mm  
 Medium 29-8007-13 35 x 100 mm  
 Large 29-8007-14 40 x 110 mm

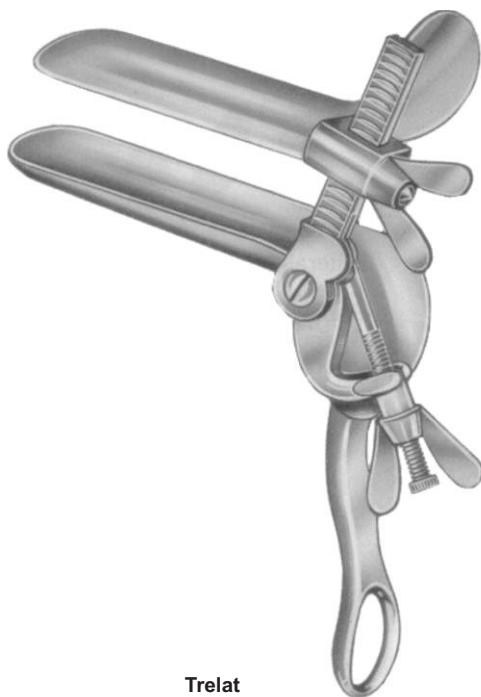

**Trelat**

	a	b
	mm	mm
29-8008-01	85	33
29-8008-02	95	35
29-8008-03	115	43



**Grave (Standard)**

	a	b
	mm	mm
29-8009-01	75	20
29-8009-02	95	35
29-8009-03	115	35
29-8009-04	125	35

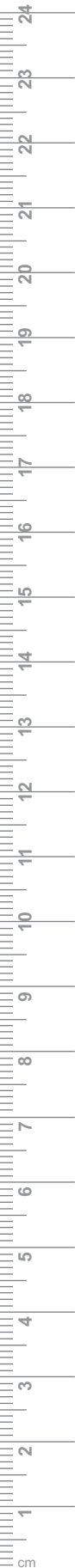



**Black**

Grave	a mm	b mm
29-8010-01	75	20
29-8010-02	95	35
29-8010-03	115	35
29-8010-04	130	25



Grave	a mm	b mm
Angled 135°		
29-8011-00	101	35



Fergusson	
29-8011-01	25mm Ø
29-8011-02	30mm Ø
29-8011-03	35mm Ø
29-8011-04	40mm Ø

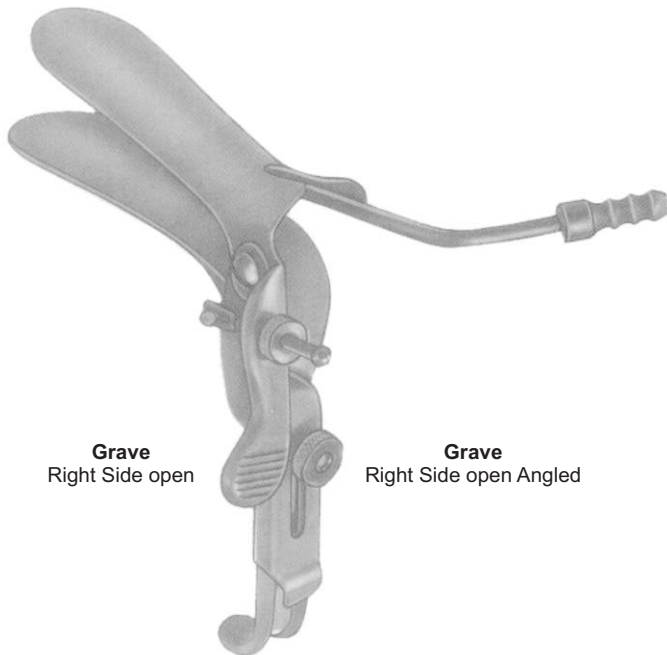

**Grave**  
Right Side open

**Grave**  
Right Side open Angled

	a mm	b mm
29-8012-01	101	35
29-8012-02		

Lateral Specula

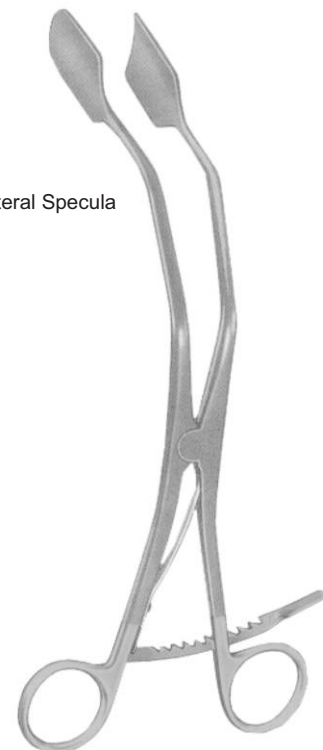

29-8013-00





**Pederson**

	a	b
	mm	mm
29-8014-01	75	13
29-8014-02	100	22
29-8014-03	120	25
29-8014-04	130	25

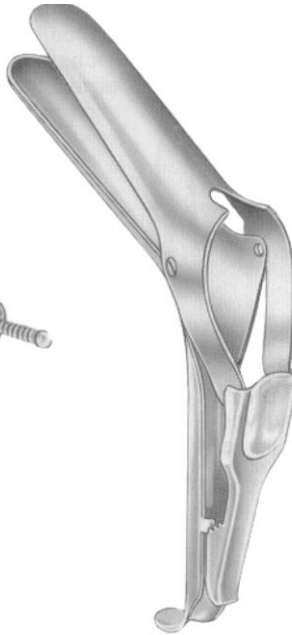

**Semm**

	a	b
	mm	mm
29-8015-01	90	14/18
29-8015-02	100	17/20
29-8015-03	100	25/30



**Nott**

	a	b
	mm	mm
29-8016-01	90	30
29-8016-02	110	30

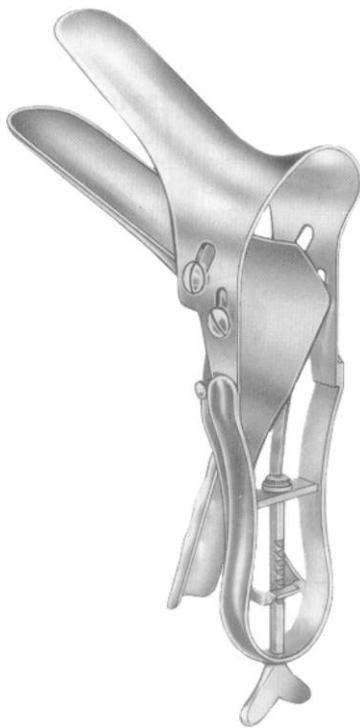

**Seyffert**

	a	b
	mm	mm
29-8017-01	100	17
29-8017-02	110	33

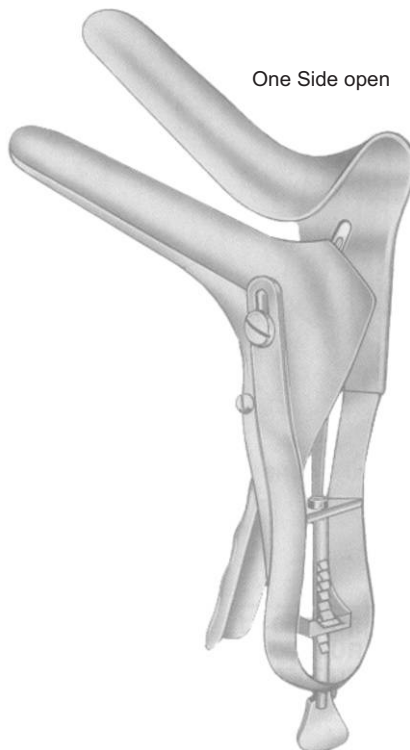

One Side open

**Seyffert**

	a	b
	mm	mm
29-8018-00	110	33



**SAKURAI'S**

29-8018-01 (LL)
29-8018-02 (L)
29-8018-03 (M)
29-8018-04 (S)





**Sims (single ended)**  
29-8019-01 63 x 32 mm  
29-8019-02 76 x 32 mm  
29-8019-03 89 x 38 mm

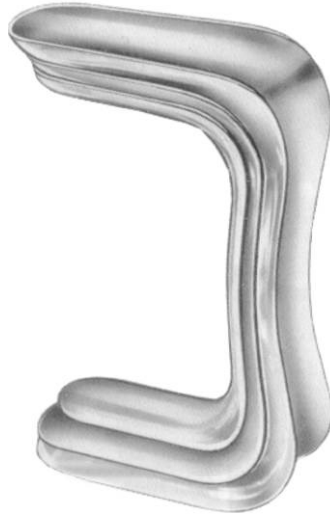

**Sims (double ended)**  
29-8020-01 65 x 25 mm (70 x 30 mm)  
29-8020-02 70 x 35 mm (70 x 35 mm)  
29-8020-03 85 x 35 mm (90 x 40 mm)  
29-8020-04 100 x 35 mm x 40 mm  
29-8020-05 120 x 35 mm x 40 mm

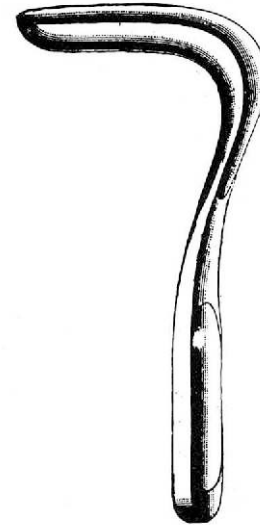

**SIMS**  
29-8020-11 60 x 25mm  
29-8020-12 70 x 30mm  
29-8020-13 80 x 35mm



**Jackson**

Fig.	a mm	b mm
29-8021-01	1	75 X 35
29-8021-02	2	90 X 35
29-8021-03	3	100 X 35
29-8021-04	4	75 X 40
29-8021-05	5	90 x 40
29-8021-06	6	100 x 40



**Eastman**

Fig.	a mm	b mm
29-8022-01	1	75 X 35
29-8022-02	2	90 X 35
29-8022-03	3	100 X 35
29-8022-04	4	75 X 40
29-8022-05	5	90 x 40
29-8022-06	6	100 x 40

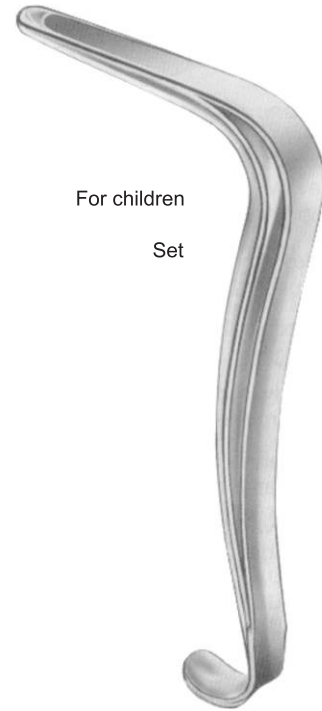

For children  
Set

**Kristeller**  
29-8023-00  
70x15 mm

Specula

Set of 1 specula and 1 retractor

- Fig. 1 29-8024-00
- Fig. 2 29-8025-00
- Fig. 3 29-8026-00

Specula

	Fig.	a mm	b mm
29-8027-01	1	70	27
29-8028-01	2	75	30
29-8029-01	3	90	36

Retractors

	Fig.	a mm	b mm
29-8030-02	1	75	23
29-8031-02	2	80	26
29-8032-02	3	95	32



**Kristeller  
(Standard)**

With conically shaped blades for virgins

Set of 1 specula and 1 retractor

- Fig. 00 29-8033-00
- Fig. 0 29-8034-00

Specula

	Fig.	a mm	b mm
29-8035-01	00	110	18
29-8036-01	0	110	21

Retractors

	Fig.	a mm	b mm
29-8037-02	00	115	14
29-8038-02	0	115	17

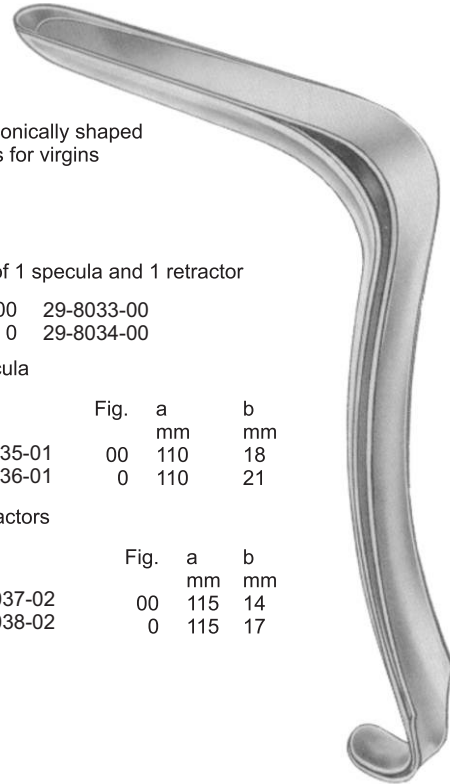

**Kristeller**

With extra long blades

Set of 1 specula and 1 retractor

- Fig. 1 29-8039-00
- Fig. 2 29-8040-00
- Fig. 3 29-8041-00

Specula

	Fig.	a mm	b mm
29-8042-01	1	110	27
29-8043-01	2	110	30
29-8044-01	3	110	36

Retractors

	Fig.	a mm	b mm
29-8045-02	1	115	23
29-8046-02	2	115	26
29-8047-02	3	115	32

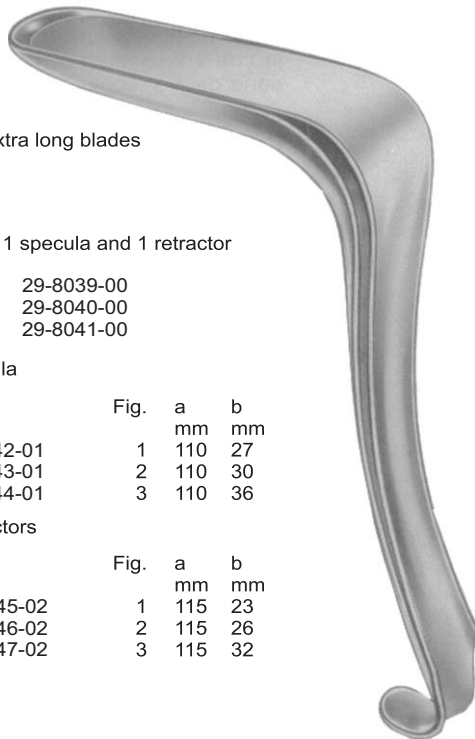

**Kristeller  
(Standard)**

With flat hollow specula



Set of 1 specula and 1 retractor

- Fig. 1 29-8048-00
- Fig. 2 29-8049-00
- Fig. 3 29-8050-00

Specula

	Fig.	a mm	b mm
29-8051-01	1	105	26
29-8052-01	2	105	28
29-8053-01	3	105	33

Retractors

	Fig.	a mm	b mm
29-8054-02	1	115	22
29-8055-02	2	115	24
29-8056-02	3	115	29

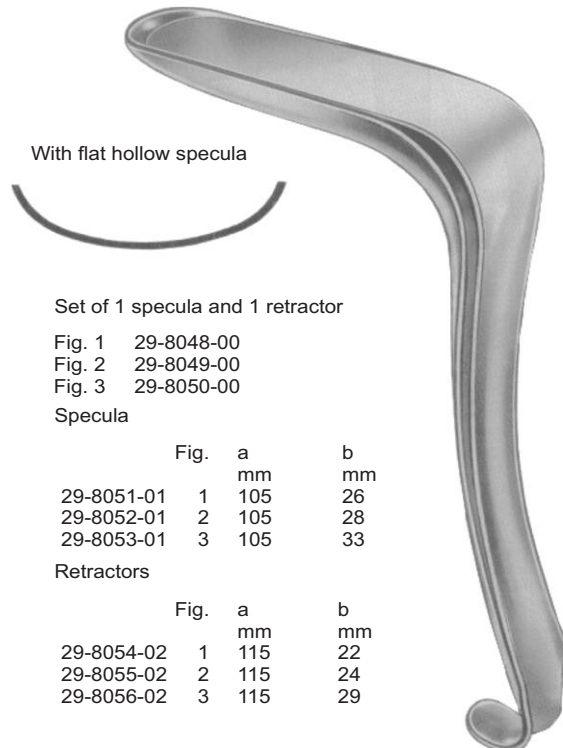

**Kristeller**

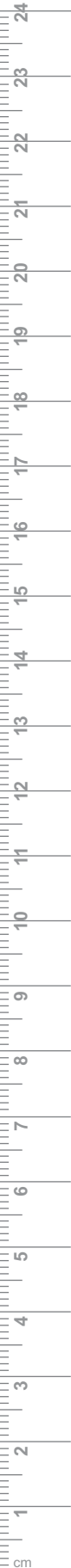

	a mm	b mm
29-8057-20	100	20
29-8057-25	100	25
29-8057-30	100	30
29-8057-35	100	35
29-8057-40	100	40
29-8058-20	130	20
29-8058-25	130	25
29-8058-30	130	30
29-8058-35	130	35
29-8058-40	130	40

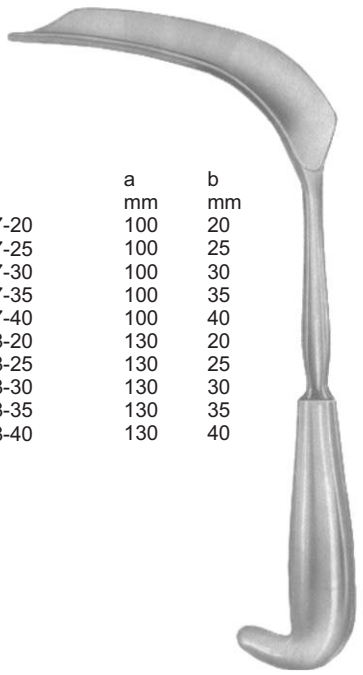

**Matzenauer**



**Braun**  
29-8059-18  
18 cm/7"  
56x13 mm



**Braun**  
29-8060-18  
18 cm/7"  
60x10 mm



**Ulrich**  
29-8061-19  
19.5 cm/7 1/2"  
80x20 mm



29-8062-19  
19 cm/7 1/2"  
85x17 mm

Set  
29-8063-00  
29-8064-00  
Specula

Fig. 1  
Fig. 2

29-8065-01  
29-8066-01

Fig.	a mm	b mm
1	70	40
2	90	40

Retractors

29-8067-02  
29-8068-02

Fig.	a mm	b mm
1	70	33
2	90	33

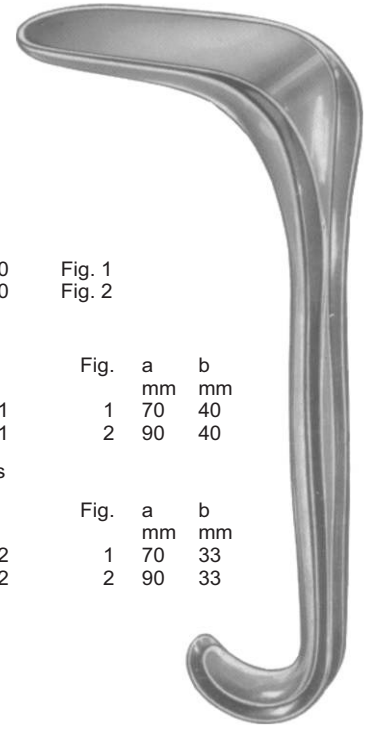

**Kallmorgen**



Specula			
	Fig. Set	a mm	b mm
29-8069-00	1	100	13/23
29-8069-01	2	100	16/30

Retractors			
	Fig. Set	a mm	b mm
29-8070-00	1	100	11/21
29-8070-01	2	100	14/27

	Fig. Set	a mm	b mm
29-8071-01	1	75	45
29-8071-02	2	90	45
29-8071-03	3	110	45

	Fig. Set	a mm	b mm
29-8072-01	1	75	45
29-8072-02	2	90	45
29-8072-03	3	110	45
29-8072-04	4	115	45

**Doyen**

**Doyen**  
 Hollow handle 28cm/11"



extra large pattern

29-8073-14  
 140 x 30mm

29-8074-13  
 135 x 36mm

29-8074-14  
 140 x 36mm





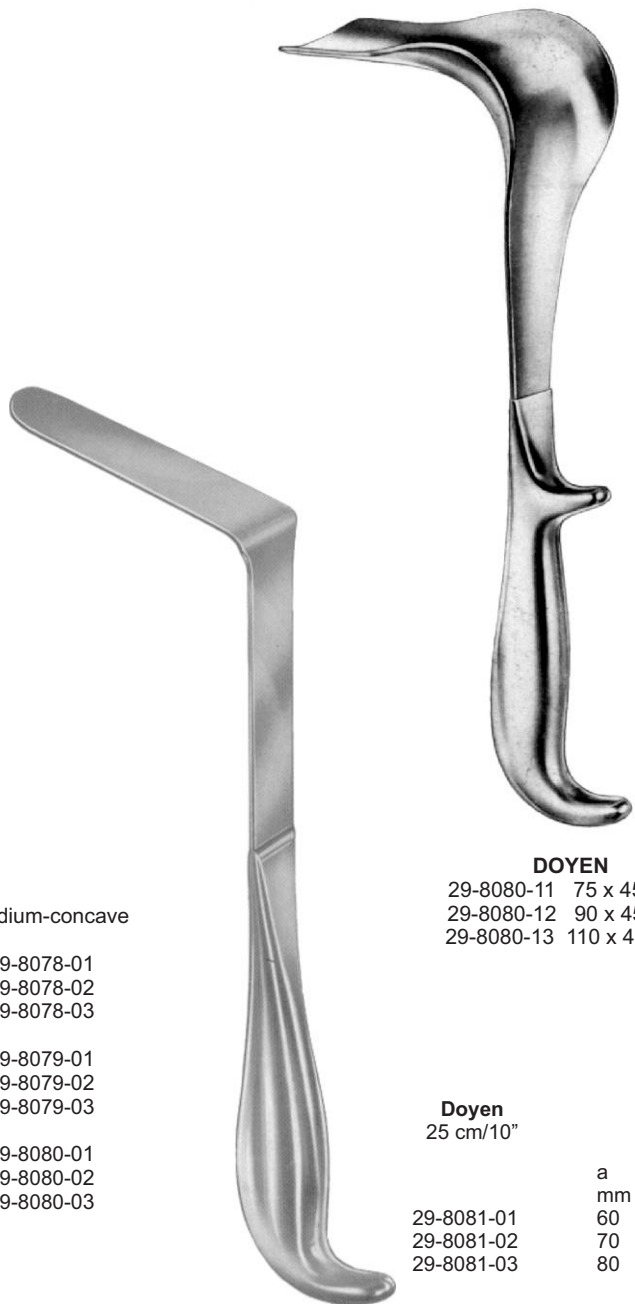
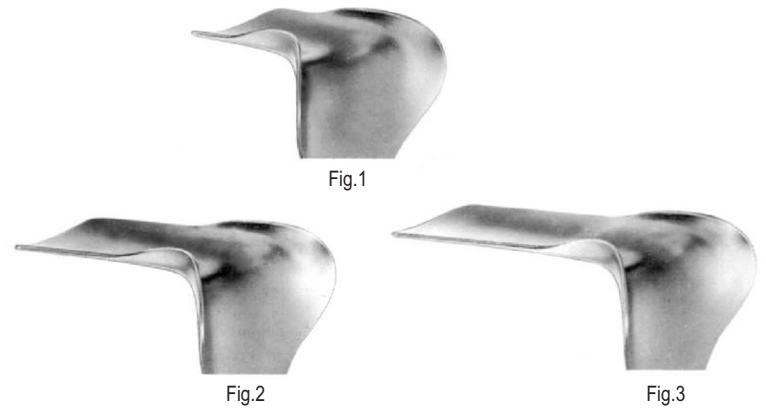
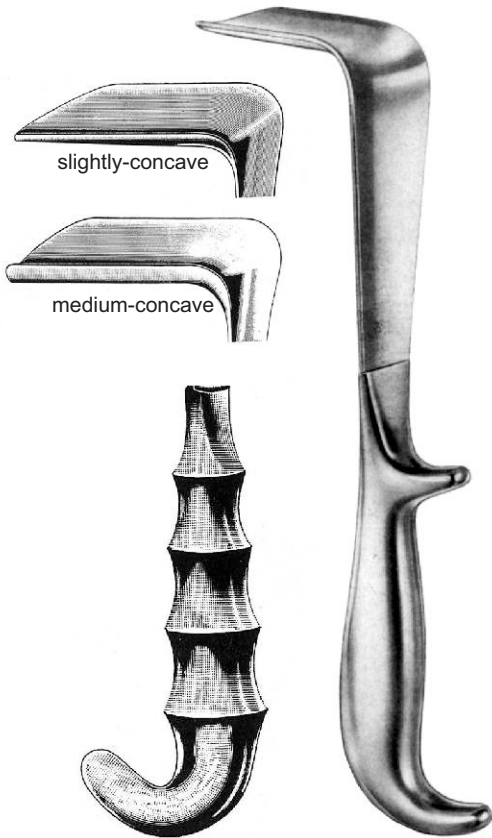
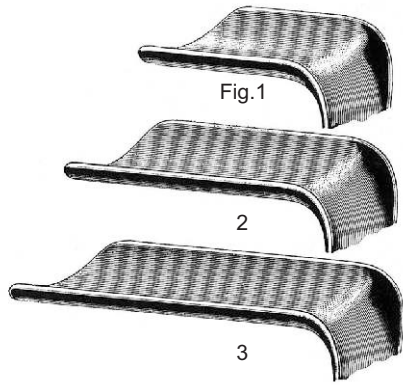

Fig	DOYEN FG		DOYEN		
	mm	mm	slightly-concave	slightly-concave	medium-concave
1	55	35	29-8075-11	29-8075-01	29-8078-01
2	85	35	29-8075-12	29-8075-02	29-8078-02
3	115	35	29-8075-13	29-8075-03	29-8078-03
1	55	45	29-8076-11	29-8076-01	29-8079-01
2	85	45	29-8076-12	29-8076-02	29-8079-02
3	115	45	29-8076-13	29-8076-03	29-8079-03
1	55	60	29-8077-11	29-8077-01	29-8080-01
2	85	60	29-8077-12	29-8077-02	29-8080-02
3	115	60	29-8077-13	29-8077-03	29-8080-03

**DOYEN**  
29-8080-11 75 x 45mm  
29-8080-12 90 x 45mm  
29-8080-13 110 x 45mm

**Doyen**  
25 cm/10"

	a mm	b mm
29-8081-01	60	30
29-8081-02	70	30
29-8081-03	80	30



Vaginal Speculas ● EN  
 Scheidenspekula ● DE  
 Espécules vaginales ● ES  
 Spécules vaginales ● FR  
 Specule vaginali ● IT

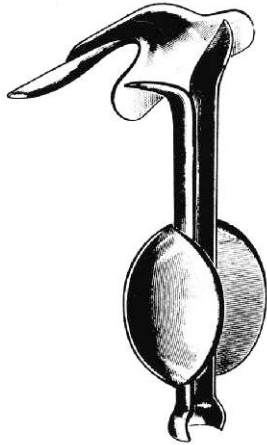

**AUVARD**  
 29-8082-01 80 x 38mm 2 lbs  
 29-8082-02 80 x 38mm 2.5 lbs  
 29-8082-03 80 x 38mm 3 lbs

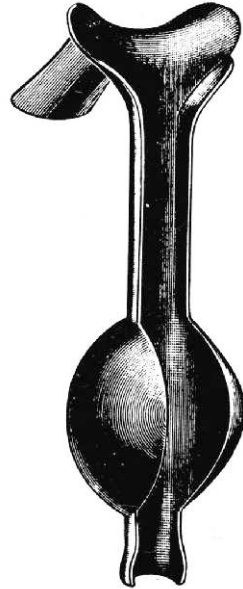

**AUVARD**  
 29-8082-00  
 68 x 40mm 3 lbs



80 x 38 mm

**AUVARD**  
 29-8082-04 2.5 lbs  
 29-8082-05 3 lbs

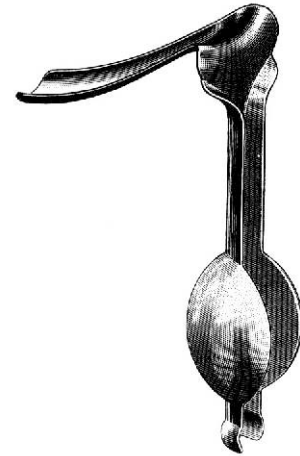

**Steiner-Auvard**  
 29-8083-01 140 x 35mm 2.5 lbs  
 29-8083-02 140 x 35mm 2.5 lbs  
 laser pattern

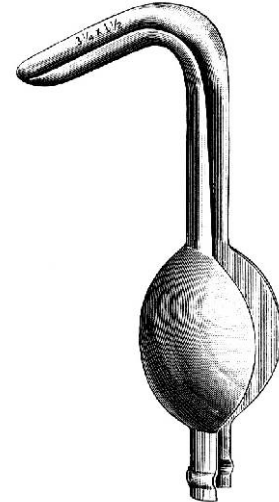

**Henrotin**  
 29-8083-03 80 x 35mm 3 lbs  
 30° blade angled down



**Landau**

	a	b
	mm	mm
29-8084-01	105	28
29-8084-02	105	38



**Dunkel**  
 29-8084-22

95 x 45 cm



**Breisky**

29-8085-20	100	20
29-8085-25	100	25
29-8085-30	100	30
29-8085-35	100	35
29-8085-40	100	40
29-8086-20	130	20
29-8086-25	130	25
29-8086-30	130	30
29-8086-35	130	35
29-8086-40	130	40
29-8087-20	160	20
29-8087-25	160	25
29-8087-30	160	30
29-8087-35	160	35
29-8087-40	160	40
29-8088-20	180	20
29-8088-25	180	25
29-8088-30	180	30
29-8088-35	180	35
29-8088-40	180	40
29-8088-50	155	40

a	b
mm	mm
100	20
100	25
100	30
100	35
100	40
130	20
130	25
130	30
130	35
130	40
160	20
160	25
160	30
160	35
160	40
180	20
180	25
180	30
180	35
180	40
155	40

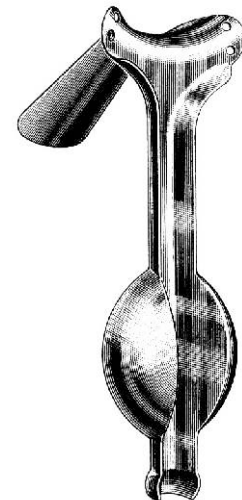

**Berlind-Auvard**  
 29-8083-04  
 105 x 40mm 2.5 lbs

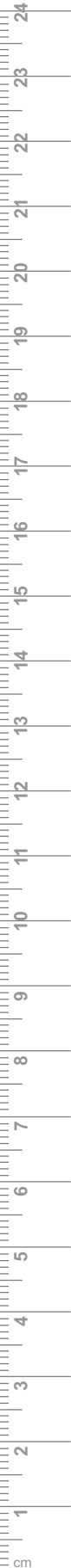



**A**  
29-8089-00  
handle only

**B**  
29-8089-10  
handle only

**BOZEMANN**

70 x 30mm  
29-8089-01

80 x 35mm  
29-8089-02

90 x 35mm  
29-8089-03

100 x 35mm  
29-8089-04

80 x 30mm  
29-8089-05

85 x 33mm  
29-8089-06

100 x 35mm  
29-8089-07

110 x 42mm  
29-8089-08

29-8089-20 compl. set with handle A, B and 8 blades  
29-8089-30 compl. set with handle A and 8 blades  
29-8089-40 compl. set with handle B and 8 blades

**Friedman**  
29-8090-20  
10 cm/4"

**Comyn Berkeley**  
Vulva self retaining  
29-8090-15  
15.5cm/6"

**Joll**  
Thyroid self retaining  
29-8091-15  
15.5cm/6"

Lateral Wall Retractors ● EN  
 Wundspreizer ● DE  
 Separadores ● ES  
 Rétracteurs muraux latéraux ● FR  
 Divaricatori a parete laterale ● IT

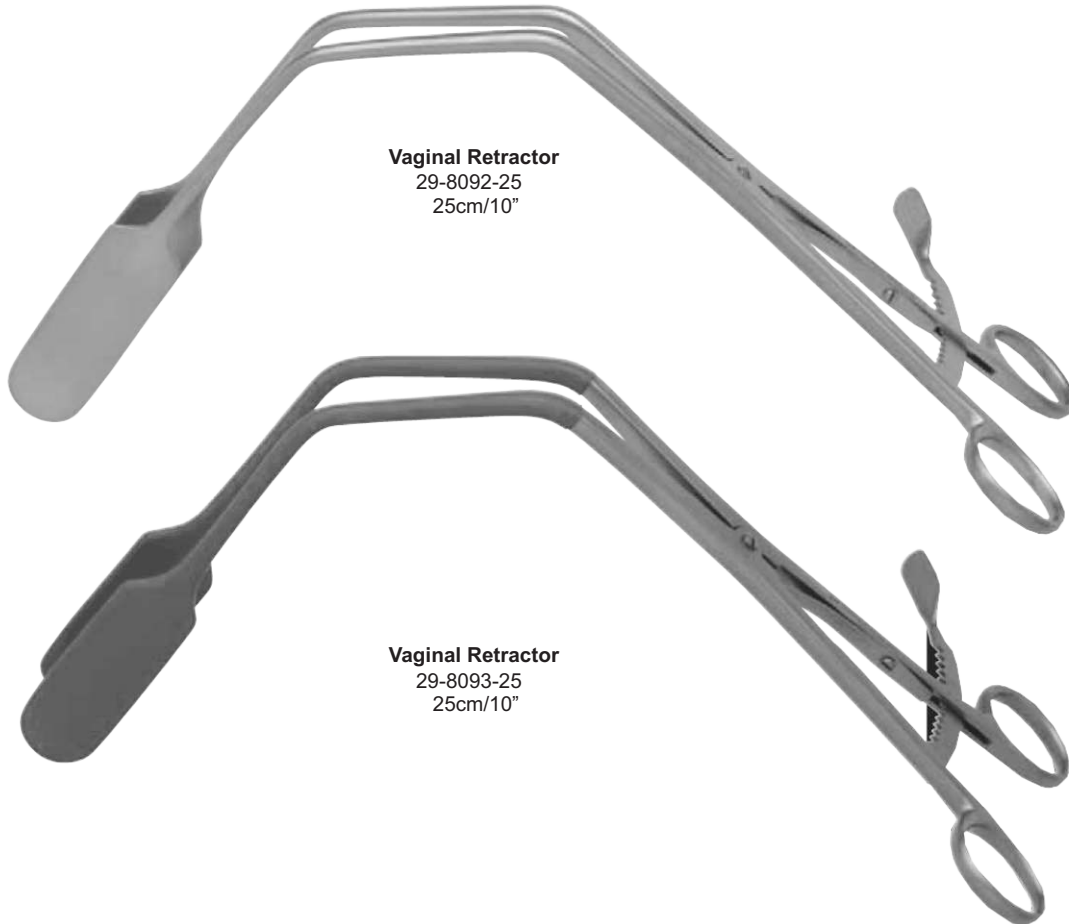
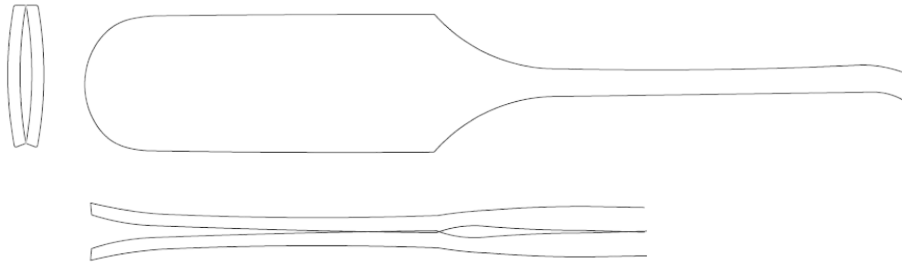

**Vaginal Retractor**  
 29-8092-25  
 25cm/10"

**Vaginal Retractor**  
 29-8093-25  
 25cm/10"





**Scherbak**  
29-8094-00 Complete  
29-8094-10 Handle only



29-8094-01  
80x30 mm



29-8094-02  
85x35 mm

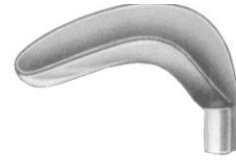

29-8094-03  
90x40 mm



29-8094-04  
55x40/60 mm



29-8094-05  
70x45/70 mm

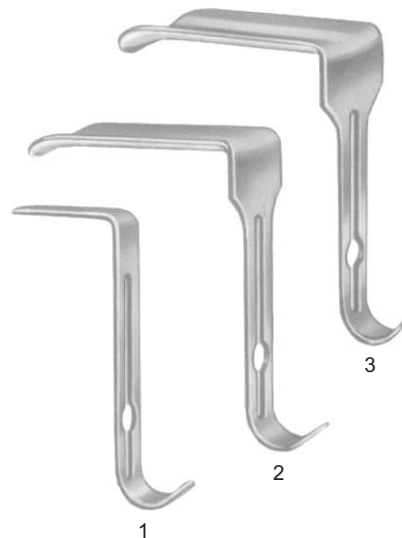
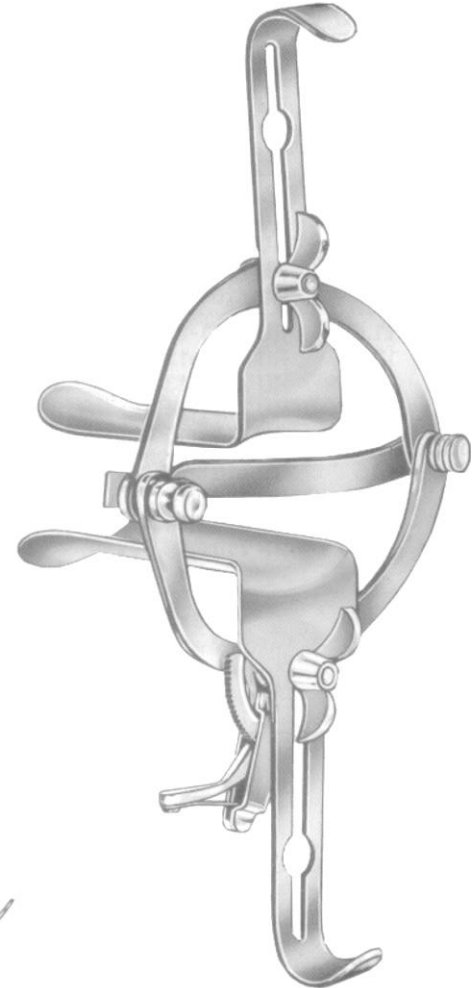

	Fig.	a mm	b mm
29-8095-01	1	45	17
29-8095-02	2	90	37
29-8095-03	3	90	45



**O'Sullivan-O'Connor**  
29-8095-00  
Complete



**Hegar**  
 single ended  
 18.5 cm long

mm Ø			mm dia.
1.0	29-8096-01	29-8096-51	1.5
2.0	29-8096-02	29-8096-52	2.5
3.0	29-8096-03	29-8096-53	3.5
4.0	29-8096-04	29-8096-54	4.5
5.0	29-8096-05	29-8096-55	5.5
6.0	29-8096-06	29-8096-56	6.5
7.0	29-8096-07	29-8096-57	7.5
8.0	29-8096-08	29-8096-58	8.5
9.0	29-8096-09	29-8096-59	9.5
10.0	29-8096-10	29-8096-60	10.5
11.0	29-8096-11	29-8096-61	11.5
12.0	29-8096-12	29-8096-62	12.5
13.0	29-8096-13	29-8096-63	13.5
14.0	29-8096-14	29-8096-64	14.5
15.0	29-8096-15	29-8096-65	15.5
16.0	29-8096-16	29-8096-66	16.5
17.0	29-8096-17	29-8096-67	17.5
18.0	29-8096-18	29-8096-68	18.5
19.0	29-8096-19	29-8096-69	19.5
20.0	29-8096-20	29-8096-70	20.5
21.0	29-8096-21	29-8096-71	21.5
22.0	29-8096-22	29-8096-72	22.5
23.0	29-8096-23	29-8096-73	23.5
24.0	29-8096-24	29-8096-74	24.5
25.0	29-8096-25	29-8096-75	25.5
26.0	29-8096-26	29-8096-76	26.5
27.0	29-8096-27	29-8096-77	27.5
28.0	29-8096-28	29-8096-78	28.5
29.0	29-8096-29	29-8096-79	29.5
30.0	29-8096-30	29-8096-80	30.5

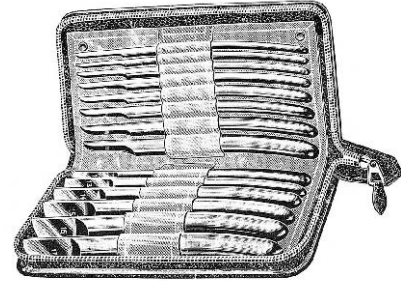

Pieces per set

29-8097-10	14	4 -17 mm
29-8097-20	26	1 - 26 mm
29-8097-30	30	1 - 30 mm

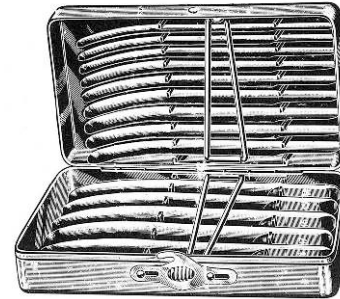

Pieces per set

29-8098-40	14	4 -17 mm
29-8098-50	26	1 - 26 mm
29-8098-60	30	1 - 30 mm



**Hegar**  
 double ended  
 20 cm long

Ø mm		
1/2	29-8099-02	
3/4	29-8099-04	
5/6	29-8099-06	
7/8	29-8099-08	
9/10	29-8099-10	
11/12	29-8099-12	
13/14	29-8099-14	
15/16	29-8099-16	
17/18	29-8099-18	
19/20	29-8099-20	
21/22	29-8099-22	
23/24	29-8099-24	
25/26	29-8099-26	

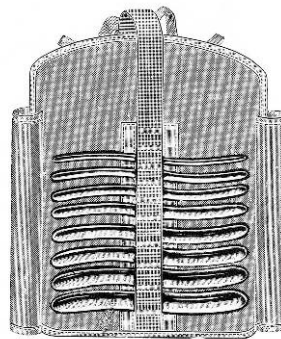

Pieces per set set

29-8100-00	08	3/4 - 17/18 mm	29-8100-30
29-8100-01	13	1/2 - 25/26 mm	29-8100-31

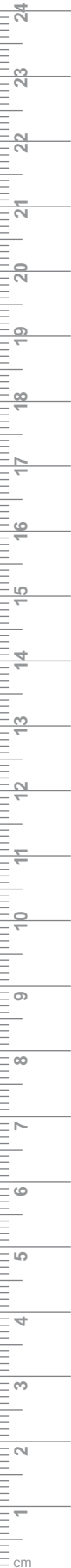
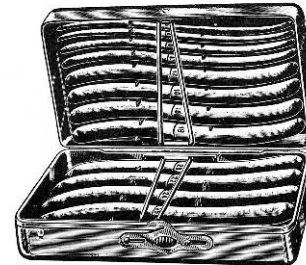





mm	
3/6	29-8102-03
4/7	29-8102-04
5/8	29-8102-05
6/9	29-8102-06
7/10	29-8102-07
8/11	29-8102-08
9/12	29-8102-09
10/13	29-8102-10
11/14	29-8102-11
12/15	29-8102-12
13/16	29-8102-13
14/17	29-8102-14
15/18	29-8102-15
16/19	29-8102-16
17/20	29-8102-17
18/21	29-8102-18

**Hawkin Ambler**

29-8101-12 Set of 12 3/6 - 14/17  
29-8101-16 Set of 16 3/6 - 18/21  
17 cm long



**Hank**  
29-8103-30

mm	
9/10	29-8104-10
11/12	29-8104-12
13/14	29-8104-14
15/16	29-8104-16
17/18	29-8104-18
19/20	29-8104-20

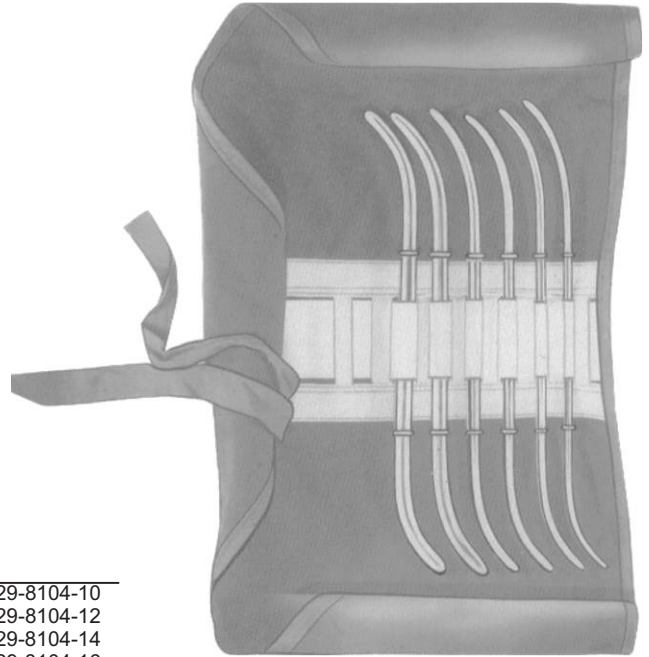

**Set**  
29-8105-00  
double ended  
27 cm



mm	
13/15	29-8106-15
17/19	29-8106-19
21/23	29-8106-23
25/27	29-8106-27
29/31	29-8106-31
33/35	29-8106-35
37/39	29-8106-39
41/43	29-8106-43

**Pratt**

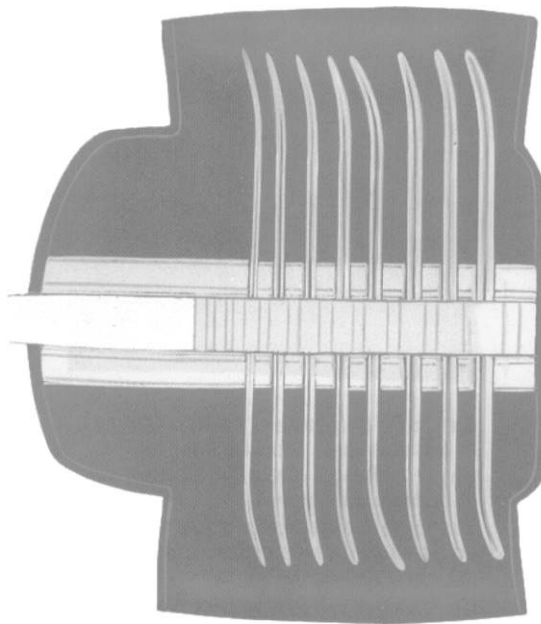

**Set**  
29-8106-00  
double ended  
29 cm

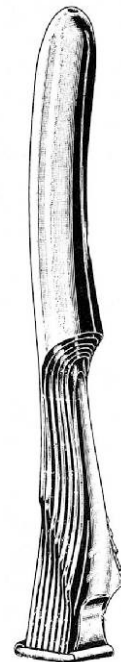

**Jolly**

29-8107-00 set of 5  
29-8107-01 3-7 mm dia  
29-8107-02 5-9 mm dia  
29-8107-03 7-12 mm dia  
29-8107-04 9-15 mm dia  
29-8107-05 12-18 mm dia



Tip 4 mm



**Sims**  
 32 cm/12½"  
 cm  
 29-8108-01 s/s



**Martin (Simpson)**  
 32 cm/12½"  
 cm  
 29-8109-01 s/s



**Valleix**  
 29-8110-25  
 25 cm/10"



**Collin**  
 29-8111-28  
 28 cm/11"

Uterine Depressor



**Braun**  
 29-8112-28  
 28 cm/11"

Rigid

Malleable

cm / in  
 29-8108-02 s/s  
 29-8108-03 c/p

cm / in  
 29-8109-02 s/s  
 29-8109-03 c/p





**SIMS**  
29-8113-26  
26.0cm



**FANO**  
29-8114-22  
22.0cm

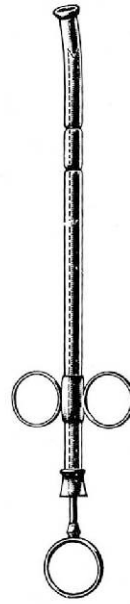

**RAPID**  
29-8115-01 200 x 8mm  
29-8115-02 250 x 10mm  
29-8115-03 250 x 12mm



**SIMS**  
29-8116-27  
27.0cm

Uterine Dilators ● EN  
 Uterus-Dilatatoren ● DE  
 Dilatadores uterinos ● ES  
 Dilateurs utérins ● FR  
 Dilatori uterini ● IT

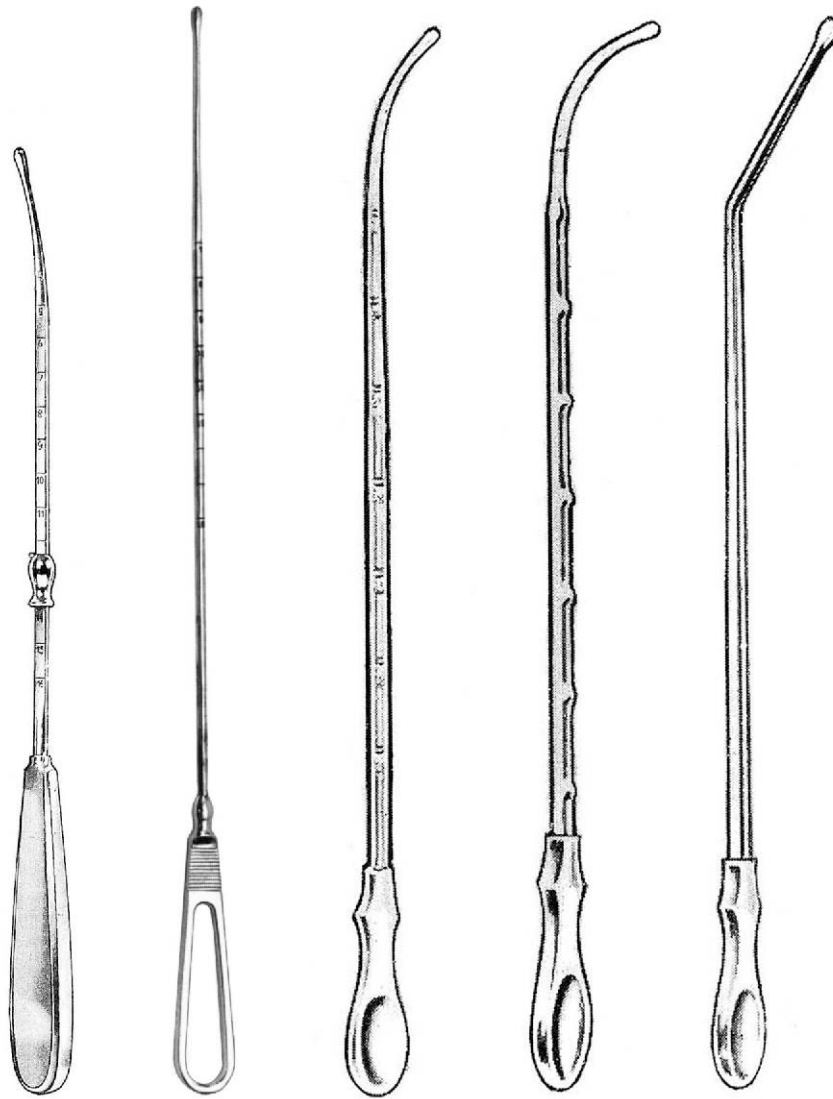

**VALLEIX**  
 29-8117-25  
 25.0cm

29-8118-30  
 30.5cm

**GALAN**  
 29-8119-32  
 32.0cm

**HORROCKS**  
 29-8120-32  
 32.0cm

**SIMPSON**  
 29-8121-32  
 32.0cm

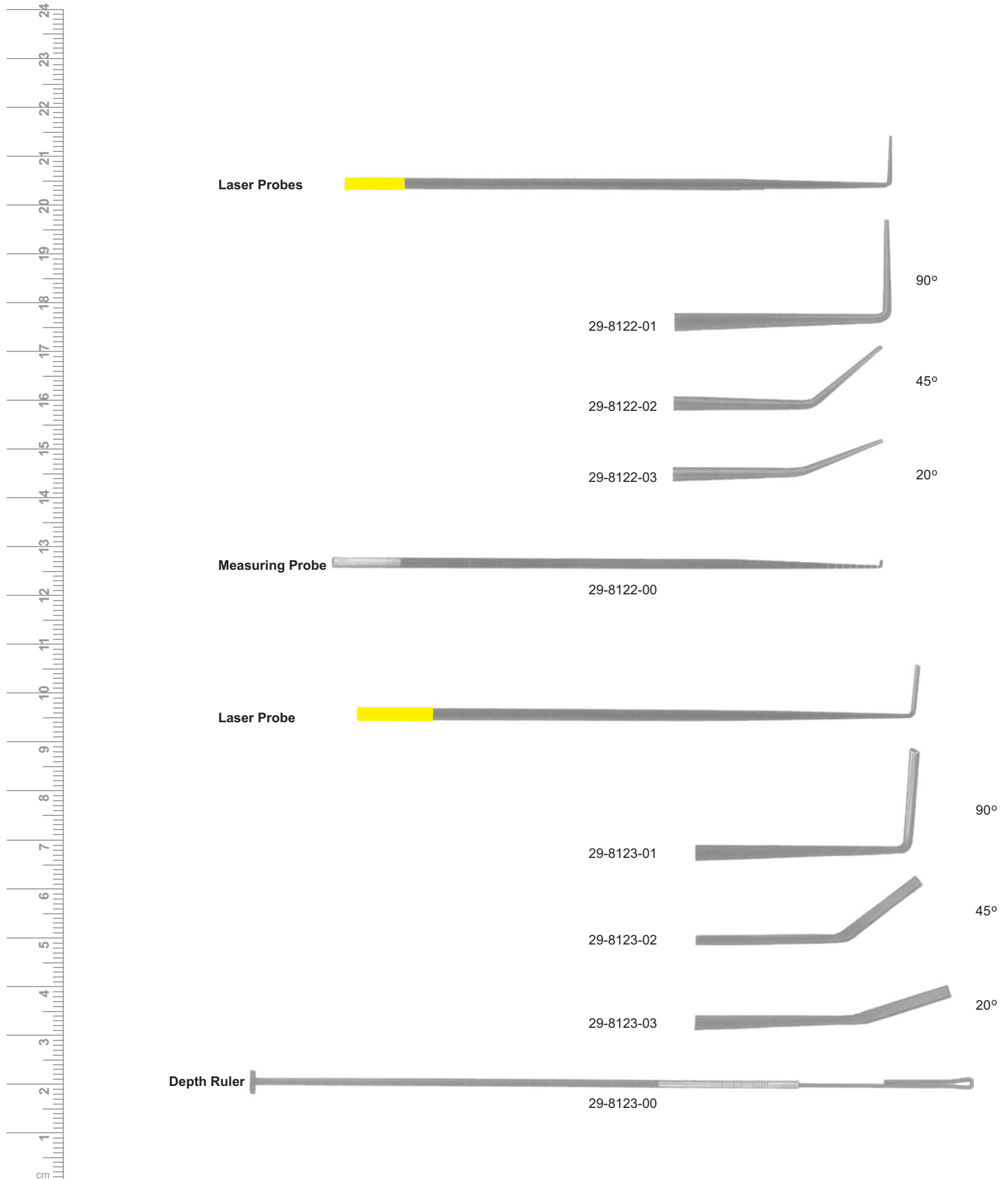

**Measuring Instruments**

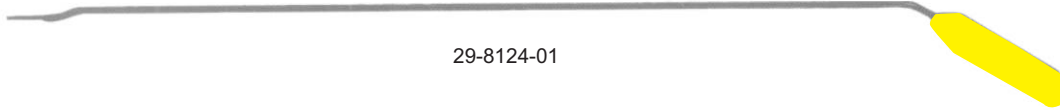

29-8124-01

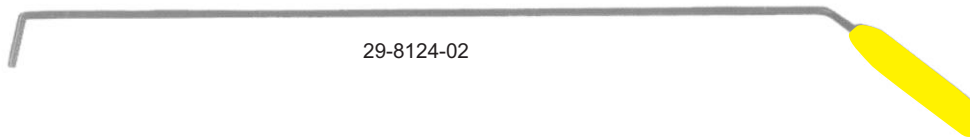

29-8124-02

**Hooks**



29-8125-01



29-8125-02 Emmet



29-8125-03



29-8126-01



29-8127-02





**Ayre**  
29-8128-23  
23 cm/9"



**Simon**  
29-8129-22  
22 cm/8¾"



**Simon**  
29-8130-22  
22 cm/8¾"



**Emmet**  
22 cm/8¾"



29-8131-01



29-8131-02



29-8131-03



29-8131-04



29-8131-05



29-8132-24  
24.0cm



**Doyen**  
29-8132-17 T-Handle  
29-8132-18 Loop-Handle  
17 cm/6¾"



**Doyen**  
29-8133-17 T-Handle  
29-8133-18 Loop-Handle  
17 cm/6¾"



**Segond**  
29-8134-27  
27 cm/10½"



GYNECOLOGY

Secretion Spoon



29-8135-27  
 27 cm/10½"



**Muenchen**  
 27 cm/10½"



29-8136-04  
 4 mm



29-8136-05  
 5 mm



**Randall**  
 24 cm/9½"

4 mmØ  
 29-8137-01 1 mm  
 29-8137-02 2 mm  
 29-8137-03 3 mm  
 29-8137-04 4 mm



**Novak**  
 23 cm/9"

29-8138-01 1 mm  
 29-8138-02 2 mm  
 29-8138-03 3 mm  
 29-8138-04 4 mm



**Novak-Schoeckaert**  
 29-8139-24  
 24 cm/9"





**Kevorkian**  
29-8140-30  
30 cm/12"

malleable  
29-8141-30  
30 cm/12"



**Kevorkian**  
29-8142-30  
30 cm/12"

malleable  
29-8143-30  
30 cm/12"



**Townsend**  
29-8144-30  
31 cm/12¼"

malleable  
29-8145-30  
31 cm/12¼"



**Duncan**  
29-8146-31  
31 cm/12¼"



**Duncan**  
29-8147-31  
31 cm/12¼"



**Goodell**  
 29-8148-34  
 34 cm/13 1/2"



**Kogan-Laser**  
 24 cm

Black Insulated



29-8149-28



29-8150-28



29-8151-28  
 28 cm/11"

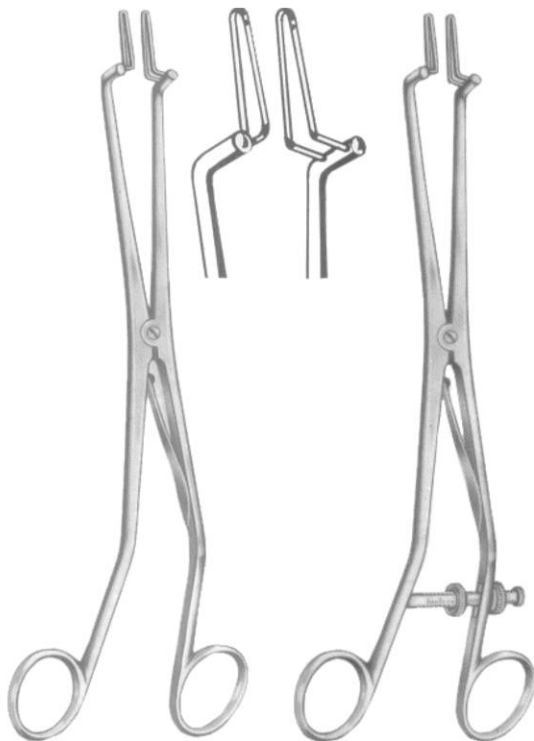

**Kogan**  
 29-8152-24 24 cm  
 29-8152-48 48 cm

**Kogan**  
 29-8153-24 24 cm  
 29-8153-48 48 cm

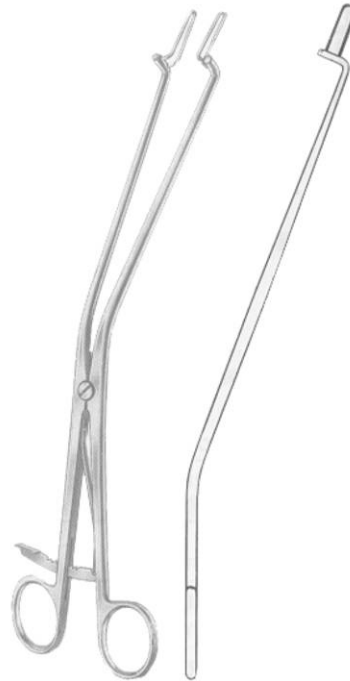

**Kogan**  
 28 cm/11"



29-8154-28



29-8155-28



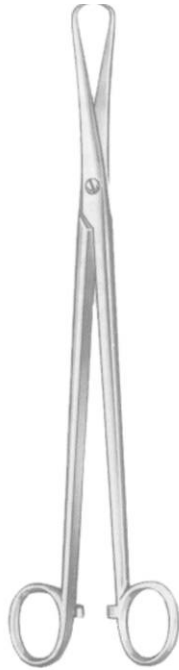

**Martin**  
29-8156-27  
27 cm/10½"

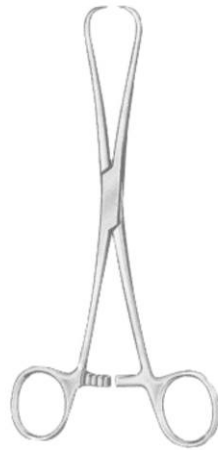

**Staude-Moore**  
29-8157-17  
17 cm/6¾"



**Barrett**  
29-8158-18  
18 cm/7"



**Schroeder**  
29-8159-10  
25 cm/10"



**Teale**  
29-8159-18 18.0cm  
29-8159-23 23.0cm  
29-8159-25 25.0cm



**Braun**  
29-8160-25  
25 cm/10"



**Collin-Pozzi**  
29-8161-25  
25 cm/10"



**Pozzi**  
29-8162-01  
25.5 cm/10¼"

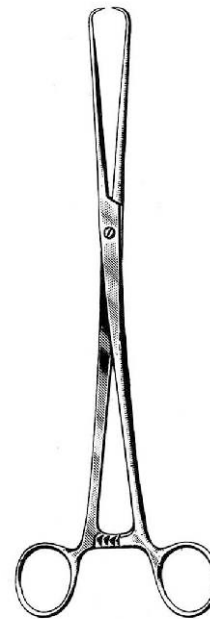

**Pozzi**  
29-8162-02  
25.0cm



**Duplay**  
29-8163-28  
28 cm/11"

Tenaculum Forceps    ● EN  
 Hakenzangen        ● DE  
 Pinzas para coger el cuello del útero    ● ES  
 Forceps Tenaculum   ● FR  
 Tenaculum Forcipe   ● IT

Amniotome for the amnion Bladder



**Skene**  
 29-8164-24  
 24 cm/9½"

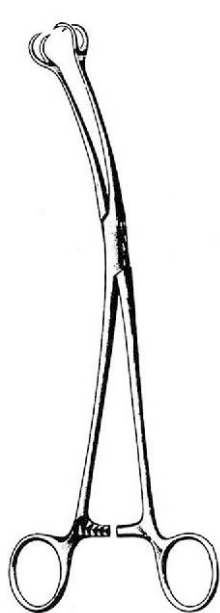

**Skene**  
 29-8164-23  
 23.0cm



**Beacham**  
 29-8165-26  
 26 cm/10¼"



**Czerny**  
 29-8166-20  
 20.5 cm/8¼"



29-8167-26  
 26 cm/10¼"



**Henrotin**  
 29-8167-20  
 20.0cm



**Abel**  
 29-8168-27  
 27.0cm



**Schroeder**  
 29-8168-23    23 cm  
 29-8168-24    24 cm  
 29-8168-26    26 cm  
 Straight



**Schroeder**  
 29-8169-23  
 29-8169-24  
 29-8169-26

Curved on Flat



**Schroeder**  
 29-8170-23  
 29-8170-24  
 29-8170-26

Curved Sideway

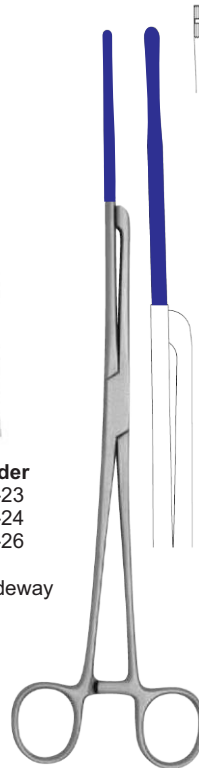

**Atrauma**  
 29-8171-29  
 Vulsellum Forcep  
 29cm/11 ½"

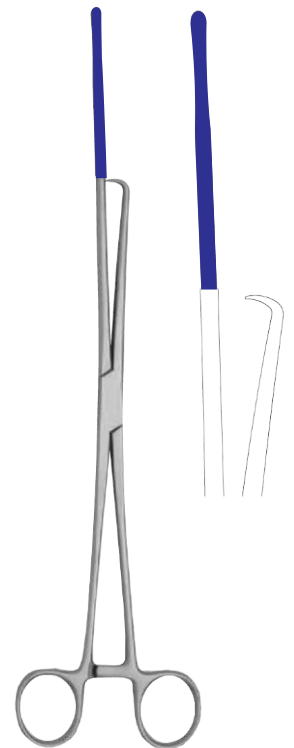

**Luer**  
 29-8172-30  
 Vulsellum Forcep  
 30.5cm/12"





**Atrauma**  
29-8173-29  
29cm/11 1/2"



**Bozeman**  
29-8174-27  
27cm/10 1/2"

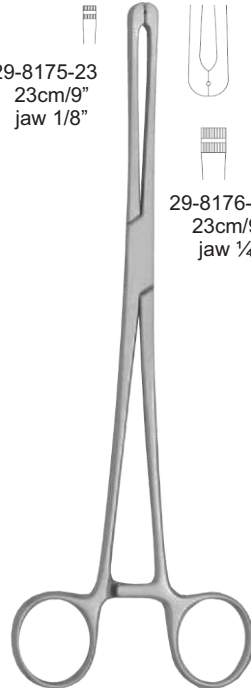

29-8175-23  
23cm/9"  
jaw 1/8"

29-8176-23  
23cm/9"  
jaw 1/4"



**Rotunda**  
29-8177-27  
27cm/10 1/2"

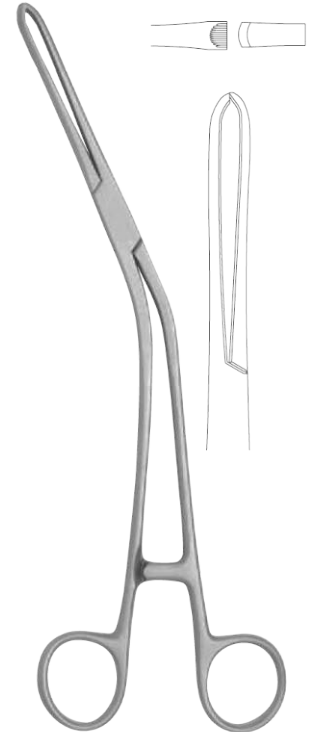

**erer**  
29-8178-24  
24cm/9 1/2"

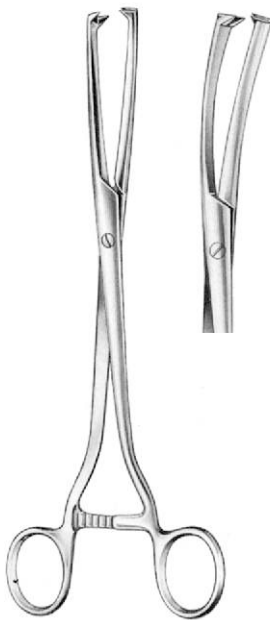

**MUSEUX** curved  
straight 24.0cm sideways

29-8179-06 6mm 29-8179-16  
29-8179-08 8mm 29-8179-18  
29-8179-10 10mm 29-8179-20

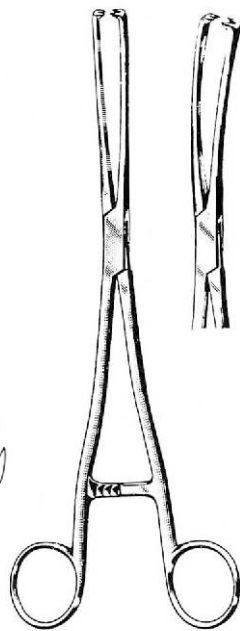

**MUSEUX** curved  
straight 24.0cm sideways

29-8180-06 6mm 29-8180-16  
29-8180-08 8mm 29-8180-18  
29-8180-10 10mm 29-8180-20

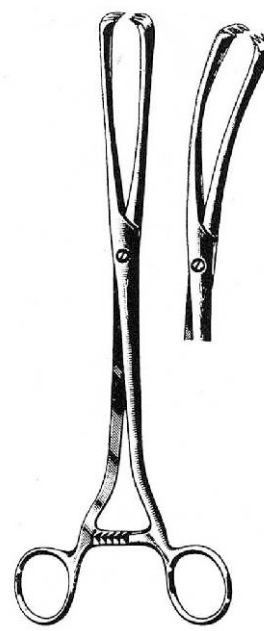

**MUSEUX** curved  
straight 26.0cm sideways

29-8181-09 9mm 29-8181-16  
29-8181-11 11mm 29-8181-18  
29-8181-13 13mm 29-8181-20

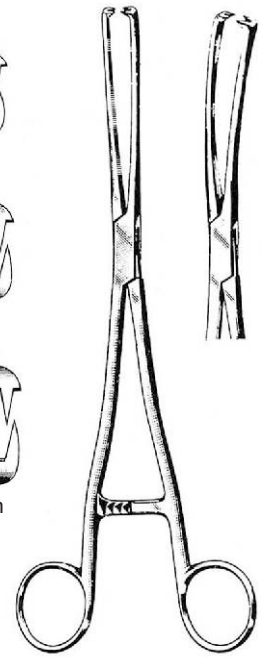

**MUSEUX** curved  
straight 26.0cm sideways

29-8182-09 9mm 29-8182-16  
29-8182-11 11mm 29-8182-18  
29-8182-13 13mm 29-8182-20



Tenaculum Forceps ● EN  
 Hakenzangen ● DE  
 Pinzas para coger el cuello del útero ● ES  
 Forceps Tenaculum ● FR  
 Tenaculum Forcipe ● IT

For the amnion Bladder



**Pratt**  
 29-8183-28  
 28 cm/11"



**Iowa**  
 29-8184-26  
 26 cm/10¼"



**Jacobs**  
 Straight 29-8185-21  
 Curved Sideway 29-8186-21  
 21 cm/8¼"



**Bonney Polypus**  
 29-8187-26  
 24 cm/9 ½"



**Kelly**  
 29-8188-32  
 32 cm/12½"



**Heywood-ith**  
 29-8189-20  
 20 cm/8"

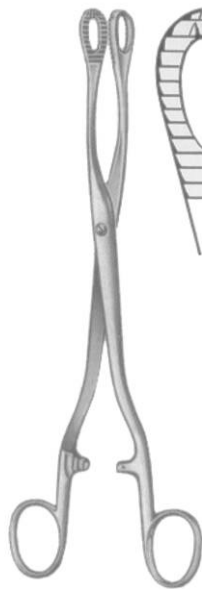

**Heywood-ith**  
 29-8190-25  
 25 cm/10"



**Noto**  
 29-8191-27  
 27 cm/10½"

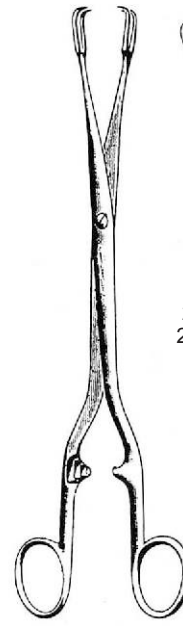

**Schroeder**  
 29-8192-01  
 26.0cm

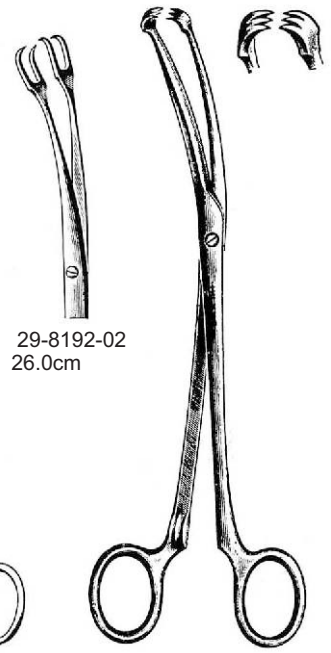

**Teale**  
 29-8193-18 18.0cm  
 29-8193-23 23.0cm

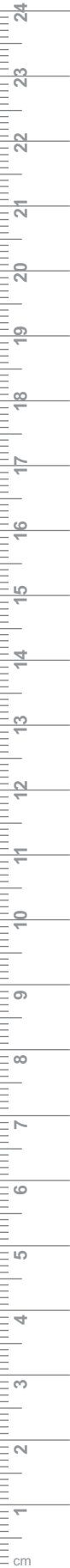



**Dartigues**  
29-8194-27  
27 cm/10½"



**Sommer**  
29-8195-23  
23 cm/9"



**Collin**  
29-8196-25  
25 cm/10"



**Doyen**  
29-8197-18 18 cm/7"  
29-8197-20 20 cm/8"

Ovarian Forceps

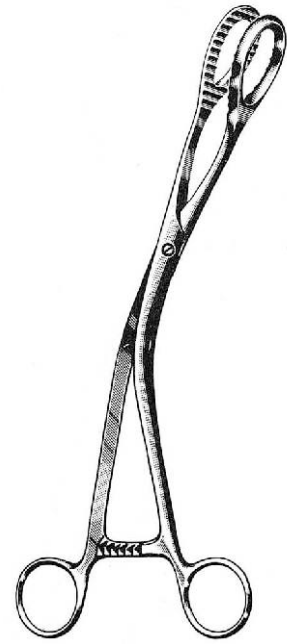

**Prueann**  
29-8197-27  
27.5cm



**Bonney**  
29-8198-27  
27 cm/11"



**Bonney**  
29-8199-27  
27 cm/10½"



**Bonney**  
29-8200-20  
20 cm/8"  
curved

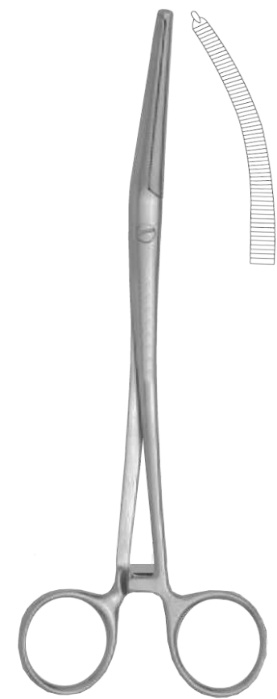

**Bonney Berkley**  
29-8201-20  
20 cm/8"  
angled

Cervical opsy and Specimen Forceps  
 Probeexzisionszangen  
 Pinzas saca-bocados para opsia  
 Pincers pour opsie cervicale et échantillon  
 opsia cervicale e pinze per campioni

- EN
- DE
- ES
- FR
- IT



**THOMS-GAYLOR**  
 29-8202-24  
 24.0cm



**THOMS-GAYLOR**  
 29-8203-22 22.0cm  
 29-8203-24 24.0cm



**VAN DOREN**  
 24.0cm

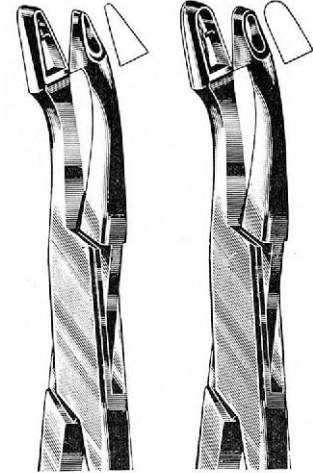

29-8204-01 29-8204-02



**GELLHORN**  
 29-8205-23  
 23.0cm



**FAURE**  
 29-8206-21  
 21.0cm



**SCHUBERT**  
 29-8207-26  
 26.0cm



**SCHUBERT**  
 29-8208-21 21.0cm  
 29-8208-29 29.0cm

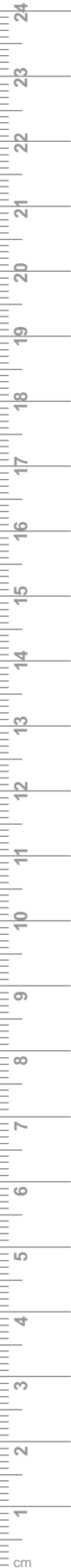

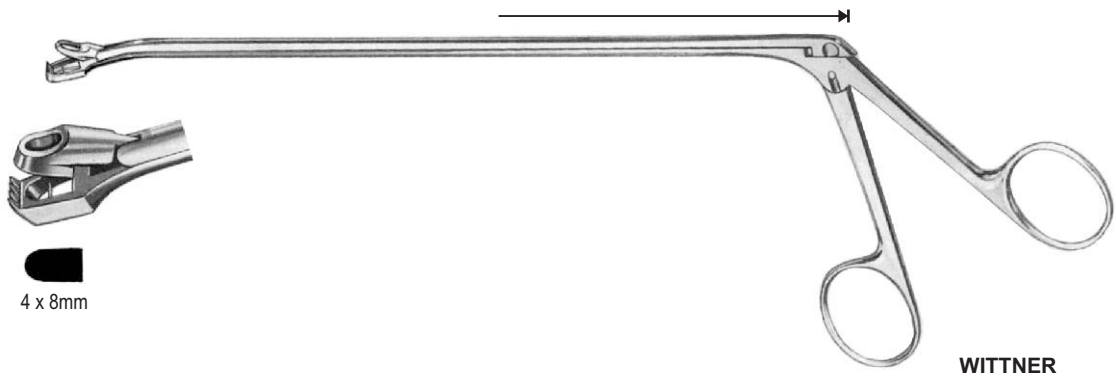

**WITTNER**  
29-8209-23 23.0cm (straight)  
29-8210-23 23.0cm (angled)

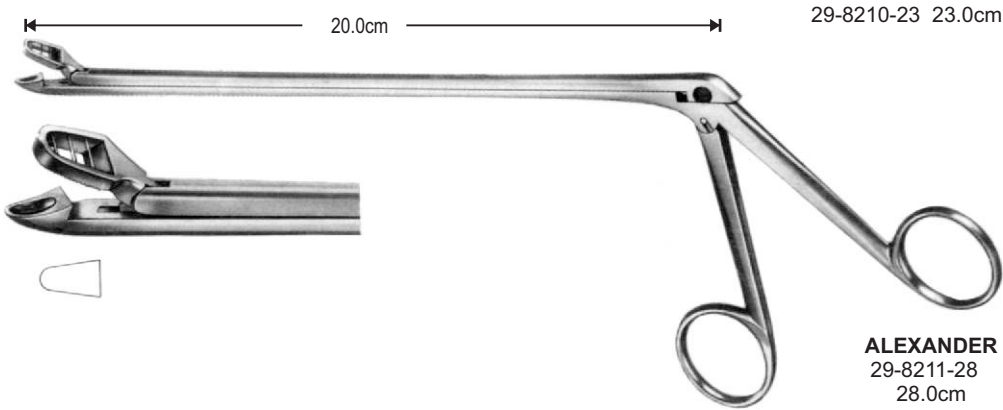

**ALEXANDER**  
29-8211-28  
28.0cm

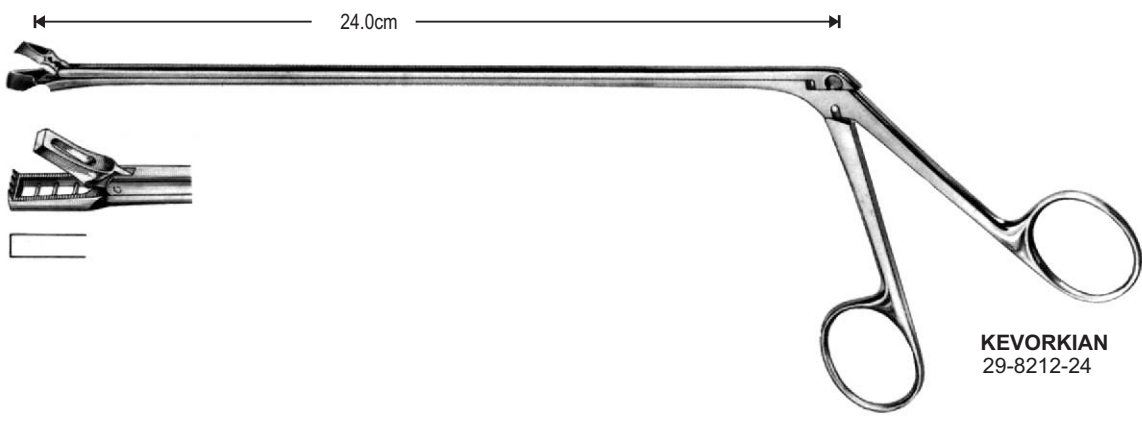

**KEVORKIAN**  
29-8212-24

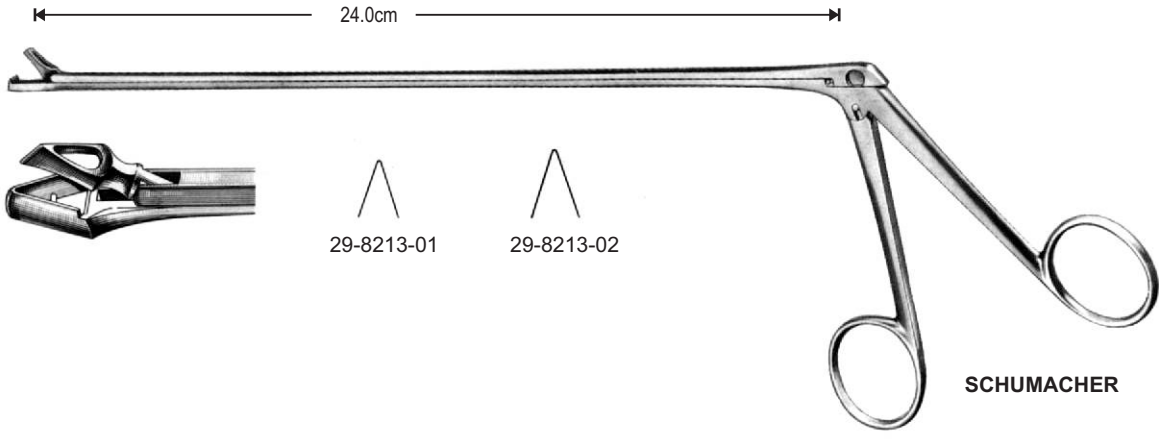

**SCHUMACHER**

Cervical opsy and Specimen Forceps  
 Probeexzisionszangen  
 Pinzas saca-bocados para opsia  
 Pincers pour opsie cervicale et échantillon  
 opsia cervicale e pinze per campioni

EN  
 DE  
 ES  
 FR  
 IT

**FAM BRO**<sup>®</sup>  
 NAME OF QUALITY INSTRUMENTS



2.3 x 4.2 mm

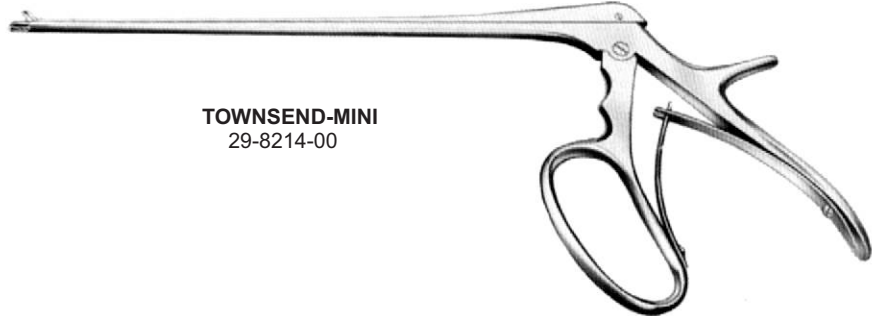

**TOWNSEND-MINI**  
 29-8214-00

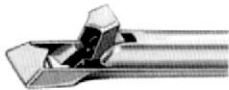

3 x 9.5 mm



**TISCHLER-KEVORKIAN**  
 29-8215-00



4 x 6.5 mm

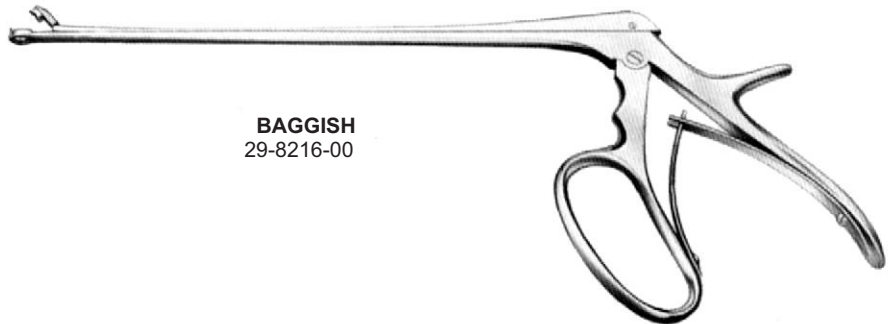

**BAGGISH**  
 29-8216-00



4 x 8 mm

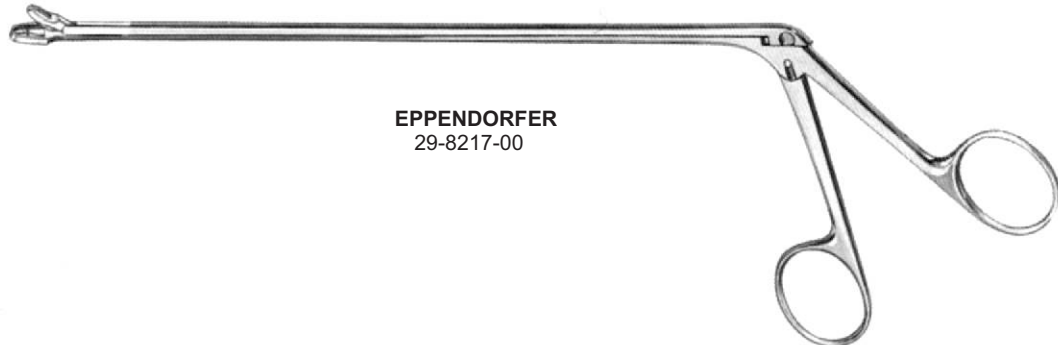

**EPPENDORFER**  
 29-8217-00

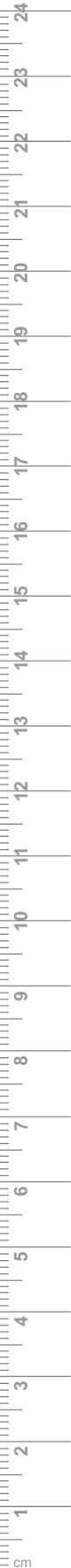



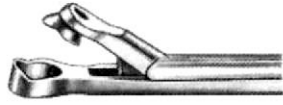

oval  
7 x 5 mm

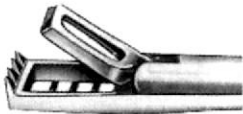

3 x 8 mm



Fig.1

TISCHLER-MORGAN



Fig.3

oval ● 3.7 x 5 mm



Fig.4

KEVORKIAN



Fig.5

mini

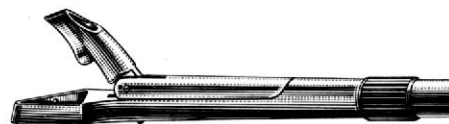

Tip only



29-8221-01

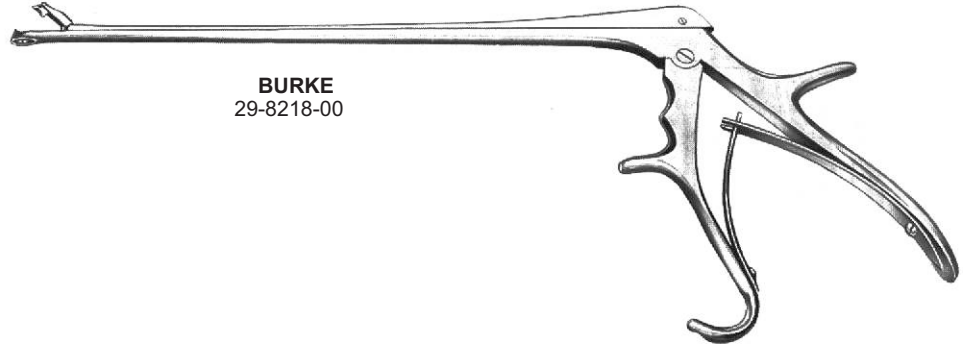

BURKE  
29-8218-00

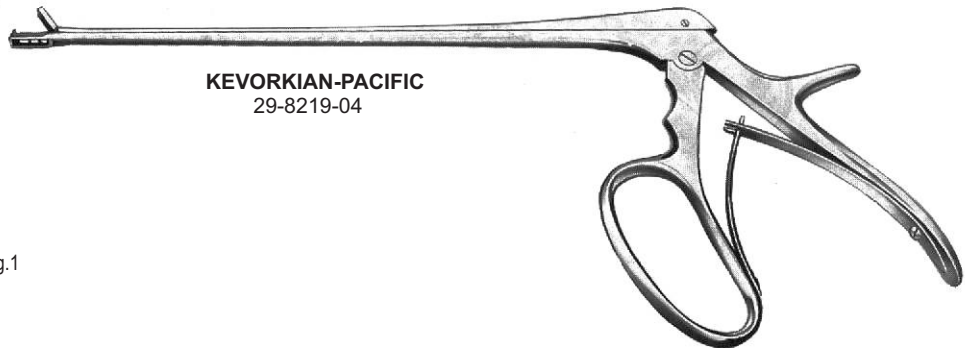

KEVORKIAN-PACIFIC  
29-8219-04

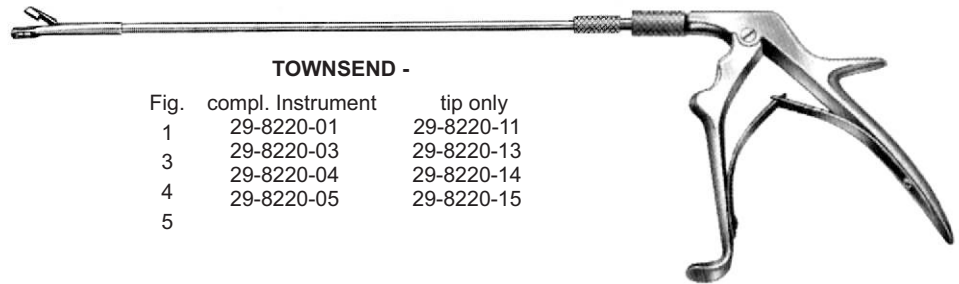

TOWNSEND -

Fig.	compl. Instrument	tip only
1	29-8220-01	29-8220-11
3	29-8220-03	29-8220-13
4	29-8220-04	29-8220-14
5	29-8220-05	29-8220-15

29-8220-99  
handle only

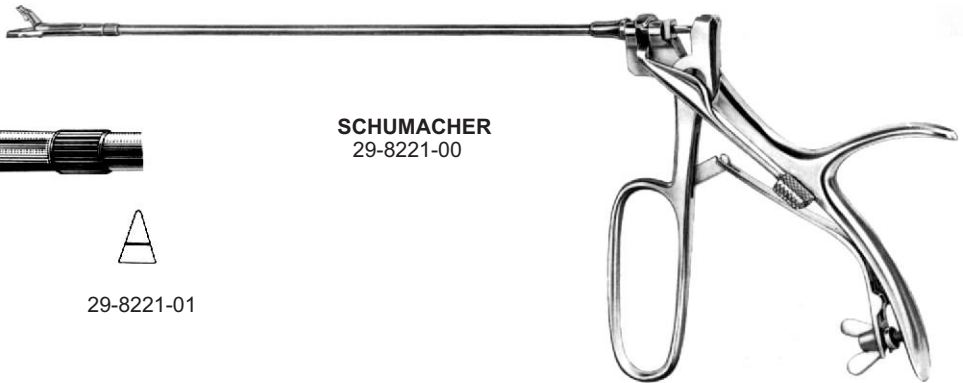

SCHUMACHER  
29-8221-00





29-8222-01

29-8222-02

29-8222-03

29-8222-04

29-8222-05

29-8222-06

**SIMON**  
 25.0cm, sharp, rigid



29-8223-01

29-8223-02

29-8223-03

29-8223-04

29-8223-05

29-8223-06

**SCHROEDER**  
 30.0cm, sharp, rigid

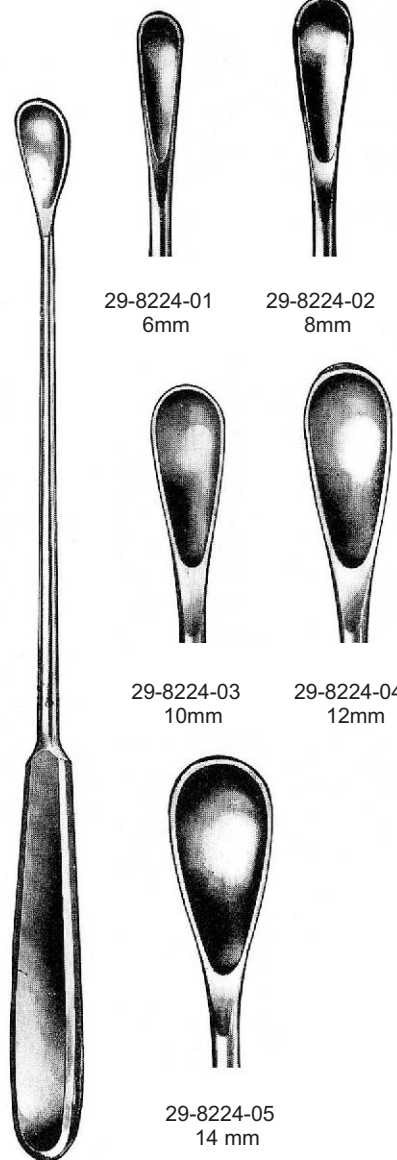

29-8224-01 6mm

29-8224-02 8mm

29-8224-03 10mm

29-8224-04 12mm

29-8224-05 14 mm

**GOURDET**  
 28.0cm, blunt

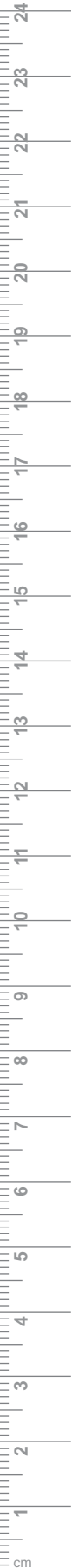

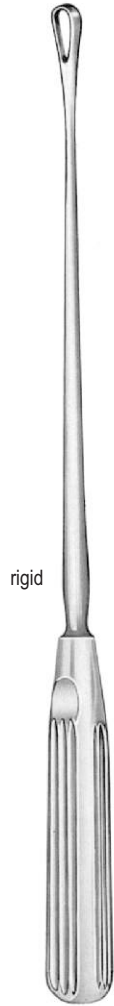

**SIMS**  
31.0cm

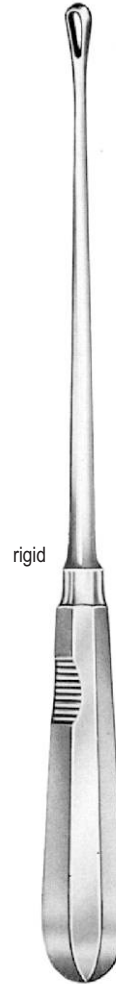
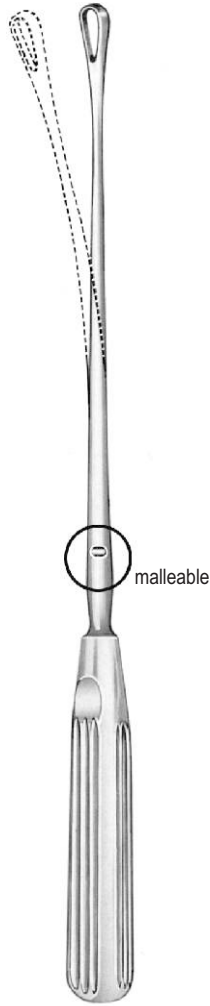

**RECAMIER**  
31.0cm



Fig	sharp	blunt	sharp	blunt	Fig	sharp	blunt	sharp	blunt
00	29-8225-05	29-8226-05	29-8227-05	29-8228-05	00	29-8229-05	29-8230-05	29-8231-05	29-8232-05
0	29-8225-06	29-8226-06	29-8227-06	29-8228-06	0	29-8229-06	29-8230-06	29-8231-06	29-8232-06
1	29-8225-07	29-8226-07	29-8227-07	29-8228-07	1	29-8229-07	29-8230-07	29-8231-07	29-8232-07
2	29-8225-08	29-8226-08	29-8227-08	29-8228-08	2	29-8229-08	29-8230-08	29-8231-08	29-8232-08
3	29-8225-09	29-8226-09	29-8227-09	29-8228-09	3	29-8229-09	29-8230-09	29-8231-09	29-8232-09
4	29-8225-11	29-8226-11	29-8227-11	29-8228-11	4	29-8229-11	29-8230-11	29-8231-11	29-8232-11
5	29-8225-12	29-8226-12	29-8227-12	29-8228-12	5	29-8229-12	29-8230-12	29-8231-12	29-8232-12
6	29-8225-14	29-8226-14	29-8227-14	29-8228-14	6	29-8229-14	29-8230-14	29-8231-14	29-8232-14
7	29-8225-15	29-8226-15	29-8227-15	29-8228-15	7	29-8229-15	29-8230-15	29-8231-15	29-8232-15
8	29-8225-16	29-8226-16	29-8227-16	29-8228-16	8	29-8229-16	29-8230-16	29-8231-16	29-8232-16
9	29-8225-19	29-8226-19	29-8227-19	29-8228-19	9	29-8229-19	29-8230-19	29-8231-19	29-8232-19
10	29-8225-20	29-8226-20	29-8227-20	29-8228-20	10	29-8229-20	29-8230-20	29-8231-20	29-8232-20
11	29-8225-21	29-8226-21	29-8227-21	29-8228-21	11	29-8229-21	29-8230-21	29-8231-21	29-8232-21
12	29-8225-23	29-8226-23	29-8227-23	29-8228-23	12	29-8229-23	29-8230-23	29-8231-23	29-8232-23
13	29-8225-25	29-8226-25	29-8227-25	29-8228-25	13	29-8229-25	29-8230-25	29-8231-25	29-8232-25
14	29-8225-30	29-8226-30	29-8227-30	29-8228-30	14	29-8229-30	29-8230-30	29-8231-30	29-8232-30
15	29-8225-35	29-8226-35	29-8227-35	29-8228-35	15	29-8229-35	29-8230-35	29-8231-35	29-8232-35
16	29-8225-40	29-8226-40	29-8227-40	29-8228-40	16	29-8229-40	29-8230-40	29-8231-40	29-8232-40

Uterine Scoops ● EN  
 Uterusloffel ● DE  
 Cucharillas uterinas ● ES  
 Scoops utérins ● FR  
 Scoop uterini ● IT

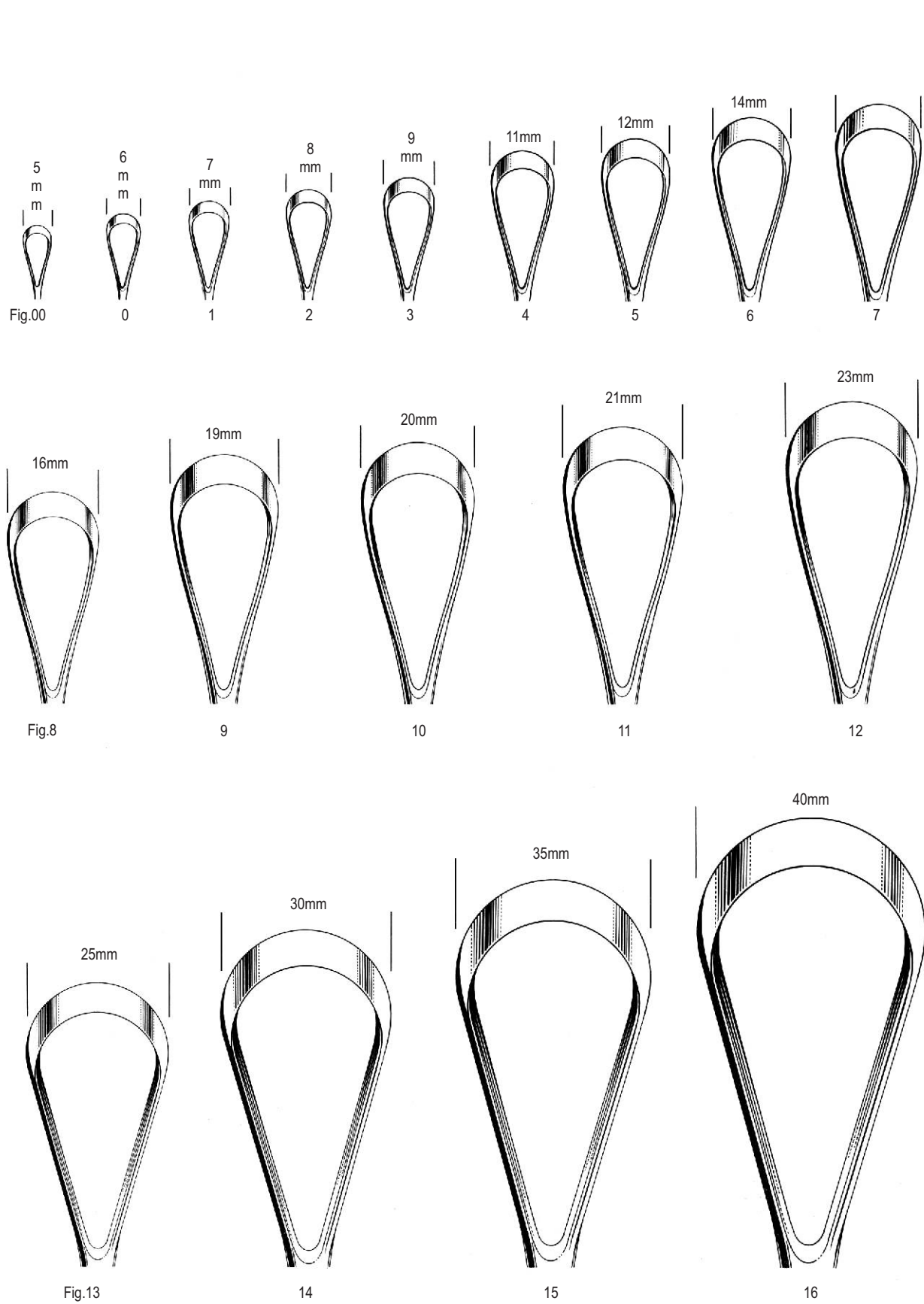



**BUMM**  
34.0cm

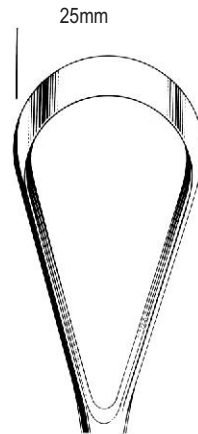
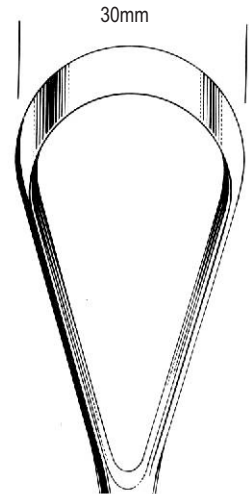
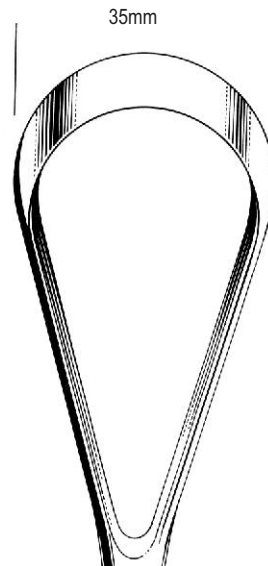

Fig. 13



14



15

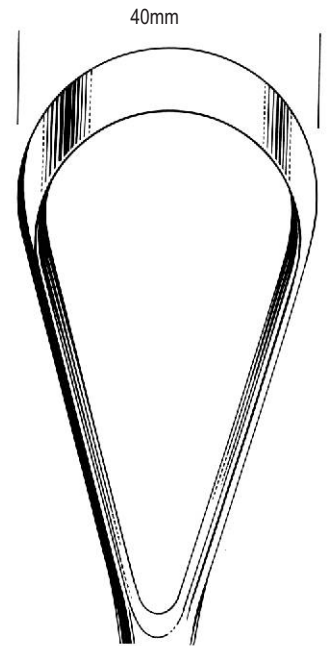

16

Fig	sharp	blunt	sharp	blunt
13	29-8233-25	29-8234-25	29-8235-25	29-8236-25
14	29-8233-30	29-8234-30	29-8235-30	29-8236-30
15	29-8233-35	29-8234-35	29-8235-35	29-8236-35
16	29-8233-40	29-8234-40	29-8235-40	29-8236-40

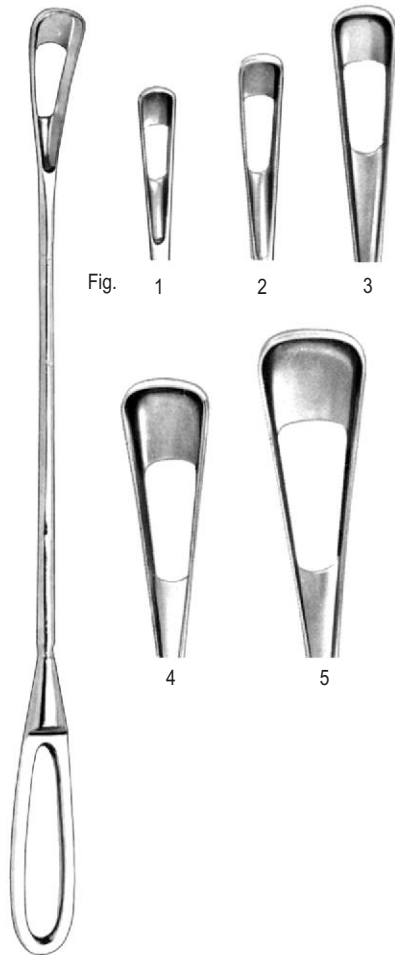

Fig. 1 2 3



4 5

28.0cm

Fig.		mm
1	29-8237-01	4,5
2	29-8237-02	6
3	29-8237-03	9
4	29-8237-04	12
5	29-8237-05	15

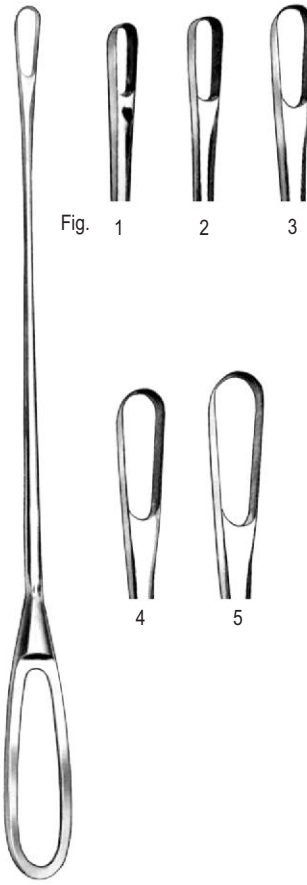

Fig. 1 2 3



4 5

27.0cm

Fig.	
1	29-8238-01
2	29-8238-02
3	29-8238-03
4	29-8238-04
5	29-8238-05

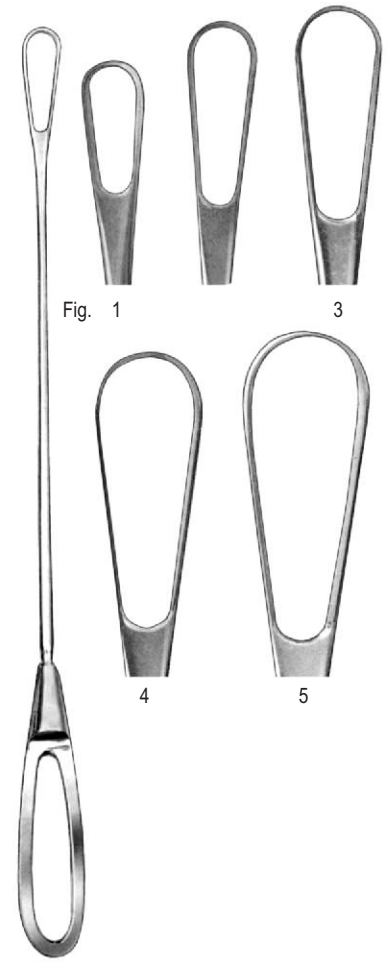
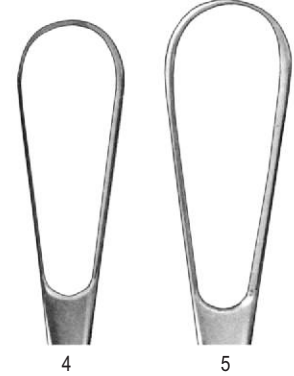

Fig. 1 3



4 5

28.0cm

Fig.	
1	29-8239-01
2	29-8239-02
3	29-8239-03
4	29-8239-04
5	29-8239-05

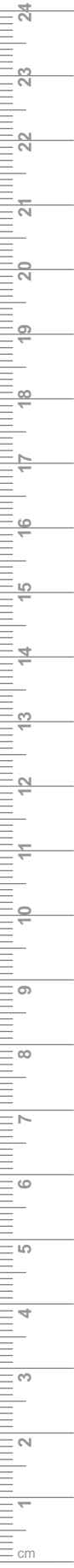

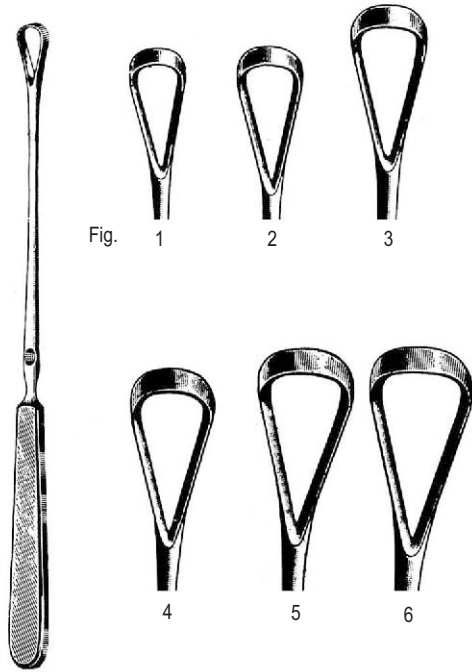

Fig.

1 2 3

4 5 6

**SIMS**  
25.0cm

sharp	Fig	blunt
29-8240-01	1	29-8241-01
29-8240-02	2	29-8241-02
29-8240-03	3	29-8241-03
29-8240-04	4	29-8241-04
29-8240-05	5	29-8241-05
29-8240-06	6	29-8241-06

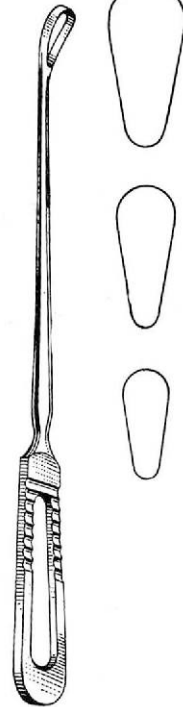

**SIMS**  
25.0cm

sharp	Fig	blunt
29-8242-01	1	29-8243-01
29-8242-02	2	29-8243-02
29-8242-03	3	29-8243-03

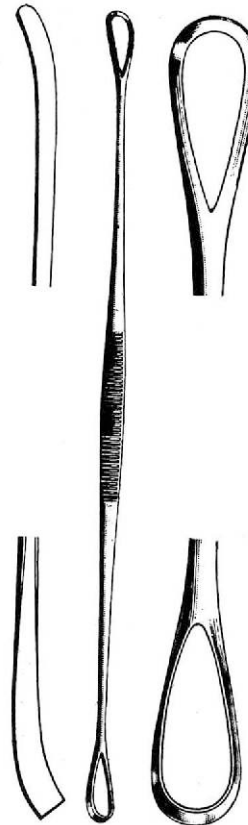

sharp / blunt  
29-8244-27 27.0cm

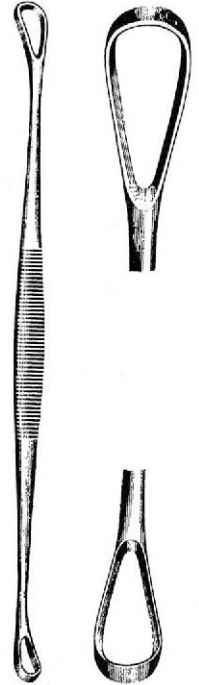

**BLAKE**  
sharp / blunt  
29-8245-27 27.0cm

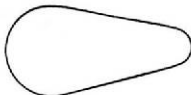

**SIMS**  
29-8246-25  
25.0cm, sharp



**SIMS**  
29-8247-25  
25.0cm, sharp / blunt







Fig.1

**UNIVERSAL**  
28.0cm

- Fig  
 1 29-8248-01  
 2 29-8248-02  
 3 29-8248-03

**RHEINSTADTER**  
29.0cm

- |            |         |            |
|------------|---------|------------|
|            | sharp   | blunt      |
| 29-8249-01 | 7.9 mm  | 29-8250-01 |
| 29-8249-02 | 11.1 mm | 29-8250-02 |
| 29-8249-03 | 14.3mm  | 29-8250-03 |

**CHELSEA HOSPITAL**  
29-8251-31 31.0cm

**DONALD**  
sharp  
29-8252-33 33.0cm



**RANDALL**  
24.0cm  
1mm dia. 29-8253-01  
2mm dia. 29-8253-02  
3mm dia. 29-8253-03  
4mm dia. 29-8253-04

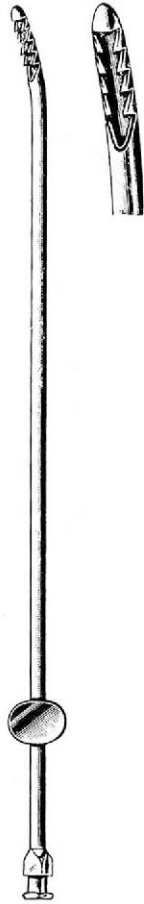

**NOVAK**  
23.0cm  
29-8254-01  
29-8254-02  
29-8254-03  
29-8254-04



**SHERMAN**  
29-8255-23 23.0cm  
3.5mm dia.

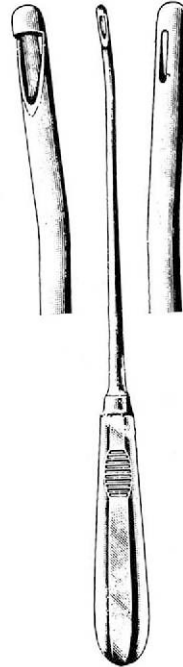

**MUENCHEN**  
29-8256-27 27.0cm

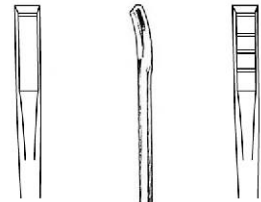

with basket

**KEVORKIAN**  
30.0cm  
29-8257-12 1.2mm 29-8258-12  
29-8257-40 4.0mm 29-8258-40